

## Installation Instructions for SED900 Outside Access Device with Lever Handle

The safety features of this product are essential to its compliance with EN1125 : 2008. No modification of any kind, other than those described in these installation instructions are permitted.

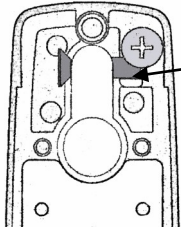

(1) Insert retaining screw into cylinder, then insert cylinder into aperture of the unit and secure as shown using dome headed screw.

(2) Determine handing from diagrams below and secure the Lever Handle as shown with the Cap Head Screw.

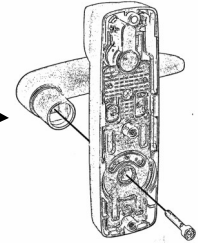

### (Right Hand Opening)

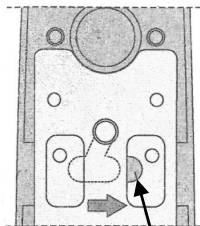

B

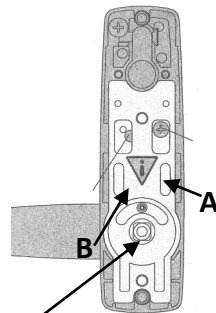
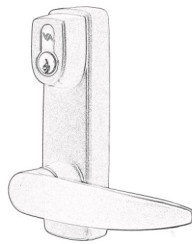

(3) To move Tongue to position B as shown, insert key into the cylinder and rotate Clockwise one revolution, then secure with a Domed Screw in position A  
**NOTE** If the key will not rotate ensure the follower (where spindle locates) is square and not rotated.

### (Left Hand Opening)

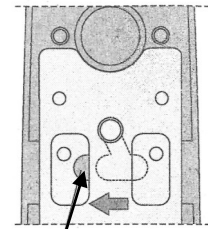

B

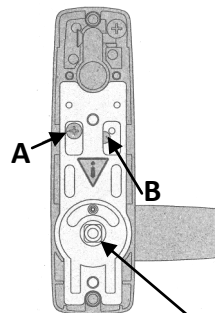
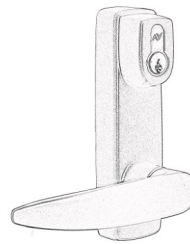

(3) To move Tongue to position B as shown, insert key into the cylinder and rotate Anti-Clockwise one revolution, then secure with a Domed Screw in position A  
**NOTE** If the key will not rotate ensure the follower (where spindle locates) is square and not rotated.

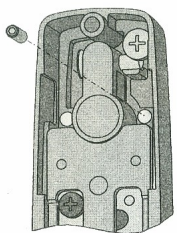

(4) To offer Key Retention, insert the grub screw as shown

(4) To offer Key Retention, insert the grub screw as shown

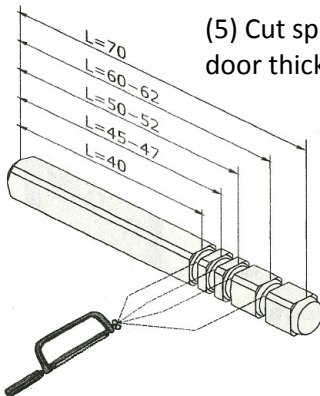
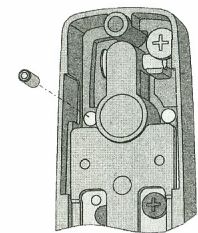

(5) Cut spindle to size to suit door thickness

(6) Drill a 15mm dia. Hole for spindle and 3 no. 8mm dia. Holes through the door and fix OAD using the two cup washers and fixing bolts. (Reduce length of bolts if necessary)

