



RadioLINK BASE

with Multiple Repeater



User Manual

Contains vital information on the products operation and installation. Read and retain carefully. If you are just installing this product **the manual MUST be given to the householder.**

Model: Ei168RC

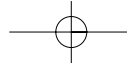

CONTENTS

	Page
1. QUICK INSTALLATION GUIDE	3
2. INTRODUCTION	4
3. INSTALLATION	5
4. THE "REPEATER" FUNCTION	10
5. TROUBLESHOOTING THE RF LINK	12
6. LIMITATIONS OF RADIO COMMUNICATIONS	13
7. CHECKING & MAINTAINING YOUR SMOKE ALARM SYSTEM	14
8. GETTING YOUR <i>RadioLINK</i> BASE SERVICED	17
9. FIVE YEAR GUARANTEE	17
10. TECHNICAL SPECIFICATION	18
11. <i>RadioLINK</i> ACCESSORIES	21

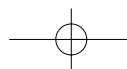
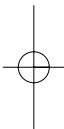

1. QUICK INSTALLATION GUIDE

For use only with Ei Electronics Easi-fit Mains Powered Smoke & Heat Alarms. The Ei168RC **RadioLINK** Base **must be installed by a qualified electrician**.

- 1.1) **Install each RadioLINK Base** in the centre of the ceiling at least 0.30m from light fittings (as per the smoke/heat alarm instructions) and connect to nearest mains circuit (see page 3).
- 1.2) **Slide alarm** on to the Ei168RC **RadioLINK** Base. This will automatically activate the rechargeable back-up cells in the base. Repeat this procedure for all alarms in the system (see page 5).
- 1.3) **To House Code**, insert a small screwdriver into the House Code switch slot of each unit in succession. This must be completed as quickly as possible (within 15 minutes) to activate the House Code mode and ensure the system only communicates with itself and not neighbouring systems (see page 6). **It is essential that the RadioLINK Bases are House Coded.**
- 1.4) **Button test** each alarm to ensure that they are all communicating.

This guide is for quick referencing only. You must read the user manual thoroughly before installation and use.

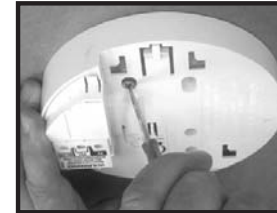

2. INTRODUCTION

The Ei168RC **RadioLINK** Base transmits a Radio Frequency (RF) alarm signal when the unit attached to it senses fire. When it receives an RF alarm signal from another Ei168RC Base, the attached smoke or heat alarm will sound. It therefore eliminates the need to run long interconnect wires between all the smoke/heat alarms on different floors and in different rooms.

It is designed for use with 'RC' Mains Powered Smoke/Heat Alarms (Ei161RC, 164RC & 166RC). The base can also be used with Ei141, Ei144 & Ei146 Easi-fit alarms provided that a Remote Control device (Ei410 or Ei411H) is **not** used in the system.

The **RadioLINK** Base, is mains powered and has rechargeable lithium cells for back-up in the event of mains failure. The **RadioLINK** Base will normally be wired to the nearest mains circuit in the ceiling (usually the lighting circuit, provided unswitched live is available). The Smoke/Heat Alarm is then slid on to the **RadioLINK** Base. Up to 12 units can be RF interconnected in this way.

It is essential to House Code the **RadioLINK Bases to ensure they will not accidentally communicate with nearby systems. This is easily done as explained in Section 3 overleaf.**

(As a safety feature the units will all communicate with each other (provided they are within range) as installed i.e. without any House Coding. The repeater function is disabled when units are not House Coded).

Various optional RadioLINK accessories are available, including the Ei411H Remote Control (for use with 'RC' alarms only). This wall-mounted device allows the

user to **Locate** the triggering alarm both when all units are sounding and when they have previously sounded (memory function - useful for troubleshooting), **Hush** any nuisance alarms and **Test** the system from a remote location.

3. INSTALLATION

WARNING: Mains operated products should be installed by a qualified electrician as per the Requirements for Electrical Installations published as IEE Wiring Regulations – BS7671 current edition. Failure to install this unit correctly may expose the user to shock or fire hazards. This unit is not waterproof and must not be exposed to dripping or splashing.

Up to twelve Ei168RC **RadioLINK** Bases can be RF interconnected in one system.

1. Select a location complying with the advice in the Smoke/Heat Alarm instruction leaflet.
2. Disconnect the AC mains supply from the circuit that is going to be used.
3. Carefully align the **RadioLINK** Base and screw into place as shown in *Figure 1*. (It is advisable at this time to use only one screw (as shown) as it allows the base to be

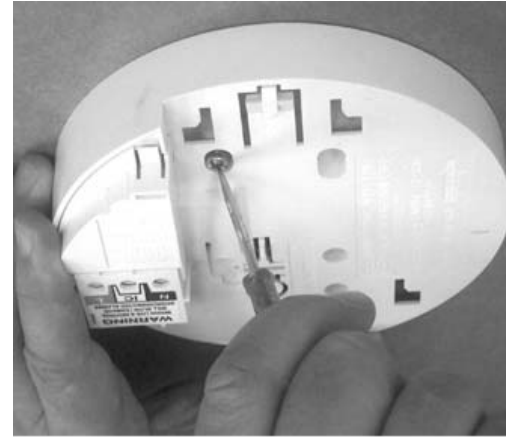

Figure 1

INSERT SCREWDRIVER TO
LIFT AND REMOVE WIRE COVER

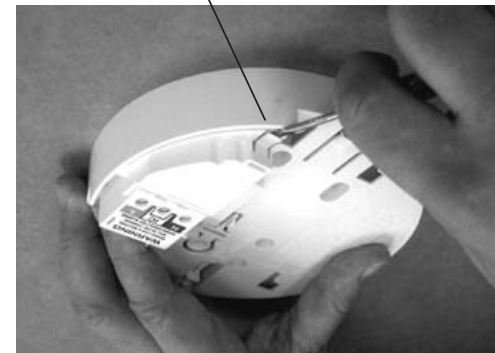

Figure 2

rotated later if required. If you use only one screw, ensure the base is secure on the ceiling before proceeding further with the installation. Remember to complete the installation by securing with the second screw after the system has been checked).

4. Lift off the wiring cover as shown in *Figure 2*.

5. If the mains wires are recessed (coming through a hole in the ceiling), bring the wires to the terminal block through the rear hole in the mounting plate as shown in *Figure 3*.

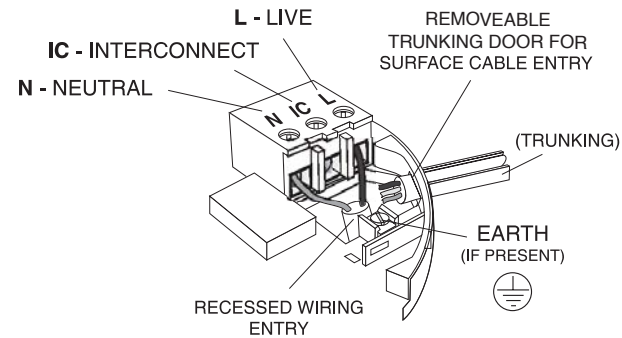

Figure 3

Ensure the rear foam gasket seals around the edge of the hole in the ceiling. This is to prevent air draughts affecting the smoke or heat entering the alarm. If the hole is too large it should be sealed with silicone rubber or equivalent (when the rest of the installation is complete).

If the mains wires are being brought along the surface:

(a) position the mounting plate so the cable trunking is as shown in *Figure 3*.

(b) Carefully cut and trim the knockouts in the **RadioLINK** Base side walls to blend with the contours of the trunking.

Important: Only cut the thinned down knockout section and leave the top intact as shown. There is only one position suitable for the surface wiring to enter the alarm.

6. The house wiring must then be connected to the terminal block on the Ei168RC **RadioLINK** Base as follows (see *Figure 3*):

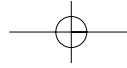

L: Live - connect to the house wires coloured brown, or marked L.

N: Neutral - connect to the house wires coloured blue, or marked N.

IC: (Hardwire Interconnect- normally not used except to hardwire interconnect to mains Smoke/Heat Alarms which don't have an Ei168RC **RadioLINK** Base)

The alarm does not need to be earthed. However the earth terminal is provided for the convenience of the installers so that any earth wire or cable coloured green & yellow, can be safety terminated.

Note: House wiring should not be “bunched up” in the area of the alarms but quickly and neatly directed away. This will minimize their effect on the radio aerial.

7. Replace the wiring cover.

8. Remove the required Smoke/ Heat Alarm from the box (discard the mounting plate supplied). Carefully line up the Smoke/Heat Alarm on the Ei168RC **RadioLINK** Base and slide it on (see Figure 4).

9. Connect the mains power to the alarm circuit. Check the green light is on. If the amber light flashes every 10 seconds, remove the alarm (see

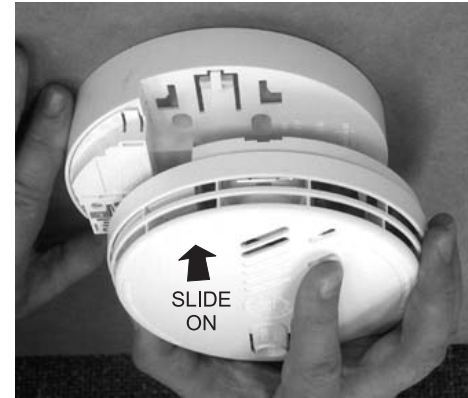
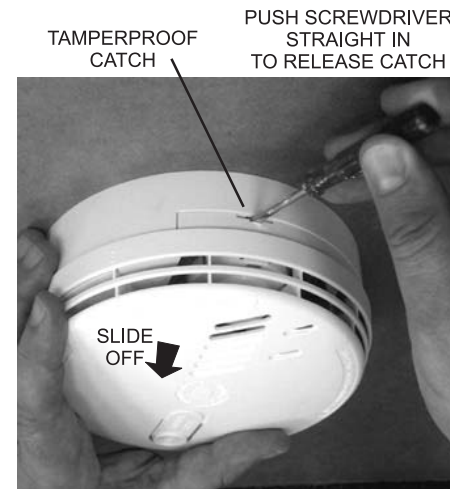

Figure 4



(PUSH COVER BACK)

WARNING: DISCONNECT MAINS BEFORE REMOVING ALARM

Figure 5

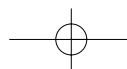

Figure 5) and manually depress the rechargeable cell "on" switch as shown in Figure 7 and refit the alarm. If there is still a problem the cells may be depleted so leave the unit on mains power for 2 hours to charge and test again.

Similarly, install all the other Smoke/Heat Alarms with their Ei168RC **RadioLINK** Bases.

10. Press and hold the House Code switch on the side of any one of the **RadioLINK** Bases with a small screwdriver (as shown in Figure 6) until the amber light illuminates.

11. Immediately release the switch and the amber light will flash quickly a few times. The amber light will then flash every 5 or 10 seconds (depending on number of units coded - see below). Repeat this action on all other **RadioLINK** Bases in the property as quickly as possible (within 15 minutes). (If any other **RadioLINK** accessories are to be used they must also be put into the house code mode at this time – see their instructions leaflets for details).

12. Check that all **RadioLINK** Bases have House Coded and communicate with each other by counting the number of times the amber light flashes on each base in turn. For example, 3 units in the system should give 3 short flashes every 5 seconds, 4 units should give 4 short flashes and so on, up to 12

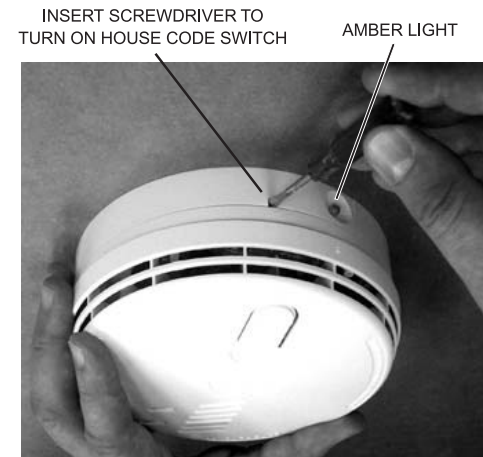

Figure 6

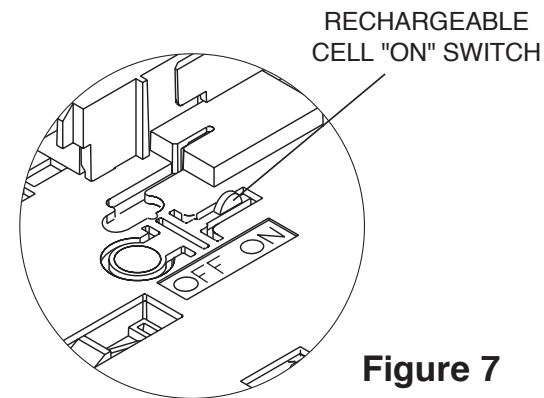
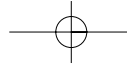

Figure 7



units. There is a long flash at 10 units to make counting easier and a further long flash at 20 units (e.g. for systems of 12 Ei168RC Bases and 8 other RadioLINK devices such as Ei407 Manual Call Point and/or Ei411H Remote Control Switch). After 12 units, the flashes are shown every 10 seconds. For example, with 13 units in the system there should be 9 short flashes + 1 long flash + 3 short flashes, every 10 seconds. It may take up to 30 minutes for all the units in the system to be House Coded correctly. If at the end of this period certain units do not show the correct number of flashes, repeat the process (from point 10 above) once more and if this fails see *Section 5*.

13. The units will automatically exit the House Code learn mode after 30 minutes however **we recommend that you manually exit the House Code mode** by re-pressing and holding the House Code switch on one of the units in the system until the amber light turns on, then release. The amber light should stop flashing and an 'exit House Code' signal will be sent to all other units. Check that the amber lights on all other units have stopped flashing. (If some units are still flashing it may indicate a problem with the radio communication from this unit to the other units). Repeat the process once more and if this fails see *Section 5*. Manually exiting the House Code mode reduces the risk of accidentally House Coding your RadioLINK Bases with nearby systems.

14. Check the communication by pressing the test/hush button for up to 20 seconds on each unit in turn. The alarm will sound and the amber light on the RadioLINK Base sidewall will illuminate continuously for around 3.5 seconds. All other alarms should sound (this may take up to 20 seconds as the message may need to be relayed through repeaters). Release the test button. The local alarm will cease and you should then be able to hear the other alarms sounding in the distance and then stopping. This may take up to 20 seconds (if any of the alarms do not sound, see *Section 5*).

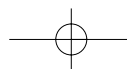

When button testing units in sequence it is important to wait 15 seconds plus a further 6 seconds per repeater between button tests (e.g. for a system with 10 repeaters, time to wait: 15 seconds + 10 x 6 seconds = 75 seconds between button tests).

Finally attach the label provided to the distribution board to identify the alarm circuits.

(Note: To clear House Codes see section 10 - Technical Specification)

4. THE "REPEATER" FUNCTION

All Ei168RC Bases are set as "Repeater" Bases as supplied. The function of a Repeater Base is to receive and then re-transmit the RF signals. This provides multiple signal paths throughout the installation to give improved RF signal reliability (with 3 or more RadioLINK Bases).

Note the "Repeater" function is not operational until all the units are put in to House Code mode.

The operation of the "Repeaters" can be observed as each unit turns on its amber light as a RadioLINK message is being repeated.

A maximum of ten RadioLINK Bases can be set as "repeaters" in any one system. If more than ten units are being installed, some of the units in the system must have their "repeater" mode de-activated. The units to de-activate should

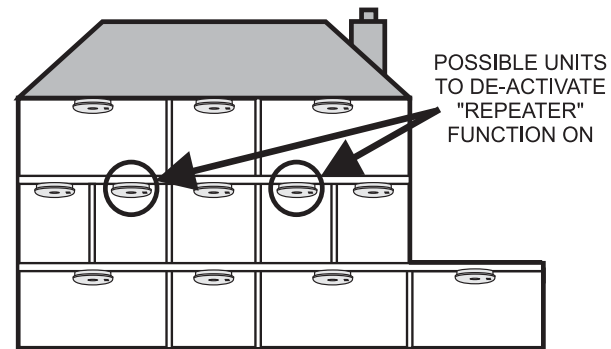

Figure 8

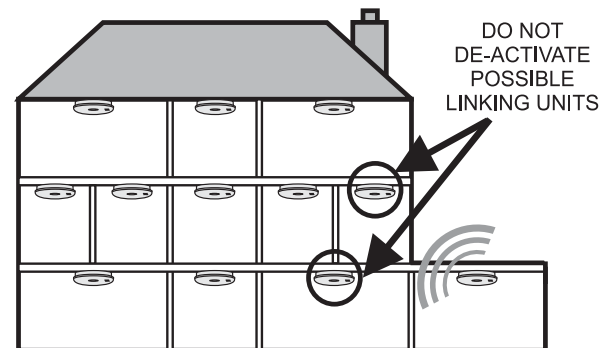
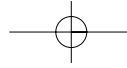

Figure 9



have repeater units around them and should not adversely affect the RF coverage throughout the system. See *Figure 8*.

Any units that may provide the only link between units on the edge of the system and the remaining units should be left as “repeaters”, as illustrated in *Figure 9*.

To de-activate the “Repeater” function:

- (i) Select a **RadioLINK** Base to de-activate based on the advice above.
- (ii) Press and hold the test button on the alarm until it sounds and the amber light on the sidewall of the **RadioLINK** base illuminates. Immediately (while amber light is still on) press and hold the House Code switch on the side of the **RadioLINK** Base with a small screwdriver until the amber light starts to flash slowly. Immediately release the switch.
- (iii) The amber light will flash slowly a total of **four** times and then stop. This indicates that the “repeater” function has been deactivated on this unit.

There may be instances where the Repeater function needs to be re-activated, in which case follow the steps below.

To re-activate the “Repeater” function:

- (i) Press and hold the test button on the alarm until it sounds and the amber light on the sidewall of the **RadioLINK** base illuminates. Immediately (while amber light is still on) press and hold the House Code switch on the side of the **RadioLINK** Base with a small screwdriver until the amber light starts to flash slowly. Release the switch.
- (ii) The amber light will flash slowly a total of **sixteen** times then stop. This indicates that the “repeater” function has been re-activated on this unit.

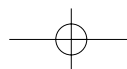

5. TROUBLESHOOTING THE RF LINK

If when checking the RadioLINK interconnection some of the alarms do not respond to the button test, then:

- (i) Ensure you have held the test button down for up to 20 seconds and the amber light has come on continuously for 3.5 seconds.
- (ii) If you have de-activated the Repeater function on a unit, try re-activating the Repeater on this unit and de-activating a different unit.
- (iii) Extend the flexible antenna from the base housing. To do this, the antenna should first be removed from its groove in the base of the unit (*see Figure 10*). Remove the breakaway section in the outer rim and push the antenna in to this groove. For improved signal strength the antenna can be pushed flat or vertical with respect to the ceiling (*see Figure 11*).

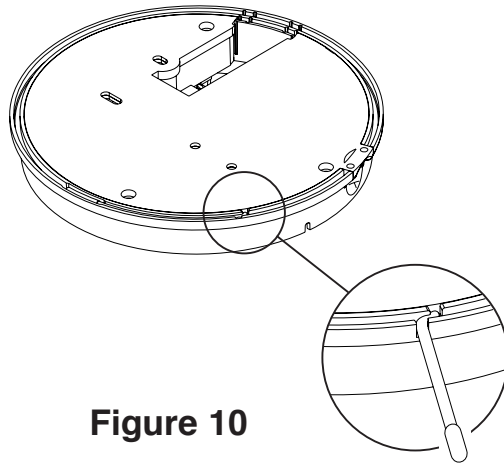

Figure 10

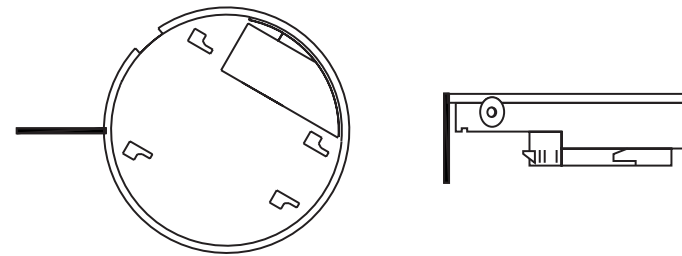

Figure 11

(iv) Re-locate/rotate the units. There are a number of reasons why the radio signals may not reach all the smoke alarms in your system (see *Section 6 on "Limitations of Radio Communications"*). Try rotating the units or re-locating the units (e.g. move them away from metal surfaces or wiring) as this can significantly improve signal reception. Rotating and/or relocating the units may move them out of the range of existing units even though they may have already been House Coded correctly in the system. It is important therefore to check that all detectors are communicating in their final installed positions. If units are rotated and/or resited, we recommend that all units are returned to the factory settings (press and hold the House Code switch on for around 6 seconds until the amber light comes on solidly and then flashes rapidly and stops. Release the House Code switch). Then House Code all units again in their final positions as per *Section 3 "Installation"* paragraphs 10 - 13. The RadioLINK interconnection should then be checked by counting the number of flashes and button testing all units.

6. LIMITATIONS OF RADIO COMMUNICATIONS

Ei Electronics radio communication systems are very reliable and are tested to high standards. However, due to their low transmitting power and limited range (required by regulatory bodies) there are some limitations to be considered:

(i) Radio equipment, such as the Ei168RC **RadioLINK** Base, should be tested regularly - at least weekly. This is to determine whether there are sources of interference preventing communication. The radio paths may be disrupted by moving furniture or renovations, and so regular testing will help identify these and other faults, so that they can be rectified (see *Section 5*).

(ii) Receivers may be blocked by radio signals occurring on or near their operating frequencies, regardless of the House Coding.

The Ei168RC **RadioLINK** Base has been tested to EN 300 220-1 V1.3.1 (2000-09) in accordance with the requirements of EN 300 220V1.1.1 (2000-09). These tests are designed to provide reasonable protection against harmful interference in residential installations. This equipment generates, uses and can radiate radio frequency energy and, if not installed and used in accordance with the instructions, may cause interference to radio and/or television reception.

However, there is no guarantee that interference will not occur in a particular installation. If this device does cause such interference, which can be verified by turning the RadioLINK device on and off (remove both the mains and turn off back-up power supplies), the user is encouraged to eliminate the interference by one or more of the following measures:

- (i) Re-orientate or re-locate the unit.
- (ii) Increase the distance between the Ei168RC and the device being affected.
- (iii) Connect the device being affected to a mains outlet on a circuit different from the one that supplies the Ei168RC.
- (iv) Consult the supplier or an experienced radio/television technician.

7. CHECKING & MAINTAINING YOUR ALARM SYSTEM

7.1 Inspection & Testing Procedure

We recommend that your Alarm System is checked directly **after installation** and

then **weekly** as below. We particularly stress the need for this check after re-occupation following a holiday etc.

(i) Check that the green mains indicator light on the cover of the alarm is on (If it is off, check circuit breakers, fuses and wiring etc.). Check the red light on the cover flashes every 40 seconds.

(ii) Press the test/hush button for up to 20 seconds on each unit. The horn will sound and the amber light on the **RadioLINK** Base sidewall will come on continuously for about 3.5 seconds. This will ensure the sensor chamber, electronics and sounder are working. A red light on the cover will flash while the horn is sounding. All other installed units should now sound. Release the test button. The local alarm will cease and you should then be able to hear the other alarms sounding in the distance (if any of the alarms do not sound see **Section 5**). Pressing the test button simulates the effect of smoke or heat during a real fire and is the best way to ensure the Alarm is operating correctly.

WARNING: DO NOT TEST WITH FLAME.

(This can set fire to the Alarm and damage the house).

We do not recommend testing with smoke or heat as the results can be misleading unless special apparatus is used.

Check for any sign of contamination such as cobwebs or dust and if necessary clean the alarm as described in the Smoke Alarm instruction leaflet.

7.2 Checking **RadioLINK** Base Battery Back-Up

It is important to check that the rechargeable back-up cells in the Ei168RC

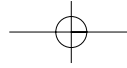

RadioLINK Base are switched on, charged, and capable of powering the system. We therefore recommend that the functioning of the mains rechargeable cell back-up is checked directly **after installation** and then **at least yearly** as follows:

(i) Check that the amber light on the side of the **RadioLINK** Base is not flashing once every 10 seconds. If it is, it indicates that the rechargeable cells in the **RadioLINK** Base are not connected or depleted. Remove the Alarm and press the rechargeable cell “on” switch (see *Figures 5 & 7*). Re-install the Smoke/Heat Alarm and re-connect the mains. If the amber light is still flashing every 10 seconds leave it for 2 hours to charge and then re-check.

(ii) Switch off or disconnect mains. The green light on the Smoke/Heat Alarm will turn off. Check the radio communication as described in *Section 7.1*. Check the battery backup as per (i) above.

(iii) If everything is satisfactory, re-connect the mains.

If the interconnect fails to operate or the amber light continues to flash every 10 seconds (even after (i) previously) then it is defective and must be replaced (see *Section 8 “Getting your **RadioLINK** Base Serviced”* below).

Further instructions are given in the instruction leaflet supplied with the Smoke/Heat Alarm regarding their maintenance and checking of their back-up supplies.

7.3 End of Life

After 10 years (see date on the side of the **RadioLINK** Base) the Ei168RC **RadioLINK** Base and the attached Smoke or Heat Alarm must be replaced.

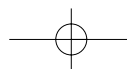

8. GETTING YOUR *RadioLINK* BASE SERVICED

If your *RadioLINK* Base fails to work after you have carefully read all the instructions, checked that the unit has been installed correctly and is receiving AC power (green light on Smoke/Heat Alarms), contact Customer Assistance at the nearest address given at the end of this leaflet. If it needs to be returned for repair or replacement, lightly press the "off" switch (see *Figure 7*) to disconnect the rechargeable cells and put both the alarm and the Ei168RC *RadioLINK* Base in a padded box and send it to "Customer Assistance and Information" at the nearest address given on the unit or in this leaflet. State the nature of the fault, where the *RadioLINK* Base and alarm were purchased and the date of purchase. Do not snap the Smoke/Heat Alarm on to the *RadioLINK* Base as this connects the battery and the unit may beep or alarm in the post.

9. FIVE YEAR GUARANTEE

Ei Electronics guarantees this *RadioLINK* Base for five years from date of purchase against any defects that are due to faulty materials or workmanship. This guarantee only applies to normal conditions of use and service and does not include damage resulting from accident, neglect, misuse, unauthorised dismantling, or contamination howsoever caused. This guarantee excludes incidental and consequential damage. This guarantee does not cover costs associated with the removal and/or installation of units. If this *RadioLINK* Base should become defective within the guarantee period, it must be returned with proof of purchase, carefully packaged, and with the problem clearly stated to one of the addresses given at the end of this leaflet (see "*Getting Your RadioLINK Base Serviced*"). We shall at our discretion repair or replace the faulty unit.

Do not interfere with the **RadioLINK** Base or attempt to tamper with it. This will invalidate the guarantee, but more importantly may expose the user to shock or fire hazards. This guarantee is in addition to your statutory rights as a consumer.

10. TECHNICAL SPECIFICATION

Mains: 230VAC

Battery Back-Up: Built-in Rechargeable Lithium Cells (up to 30 days back-up)

Approvals: Complies with EMC, Electrical Safety and Radio Regulations – including requirements of the RTTE Directive Compatibility 1999/5/EC (RF Performance to EN300220-3, EMC to EMC 301489-3) - independently tested

Humidity Range: 15% to 95% RH (non-condensing)

Radio Frequency: 868 MHz band

RF Power: +5dBm

Range: 150 meters (minimum) in free space (without use of the “Repeater” function)

RF RECEPTION

Alarm Signal Reception: Turns on horn without red light flashing for as long as it receives an alarm signal. An alarm cancel signal turns off the alarm; if no cancel signal is received it automatically turns off after 70 seconds

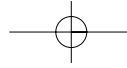

RF VISUAL INDICATOR (Amber)

On Transmission: Amber LED lights continuously for 1.5 to 3.5 seconds while messages are being transmitted. The amber light also flashes after receipt of an alarm cancel signal

Low Battery Indication: Amber light flashes every 10 seconds

Size of System: The recommended maximum is 12 Ei168RC units. In addition 8 further RadioLINK accessories (such as Ei407 Manual Call Point & Ei411H Remote Control Switch) can be used. In some installations the RF range is likely to be the limiting factor

Communication: All units will communicate together as shipped. After a unit has been House Coded it will only communicate with other units House Coded at the same time. House Coding is essential to prevent false alarms with, or from neighbouring systems. The "Repeater" function will not operate until units have been House Coded

Entering House Code Mode: Pressing and holding the House Code switch until the amber light illuminates, then releasing puts the *RadioLINK* Base into House Code mode.

House Code Mode: The *RadioLINK* Base transmits and receives specific codes. The amber light will flash every 5 or 10 seconds (depending on number of units coded - up to 12 units the flashes are every 5 seconds, above 12 units the flashes are every 10 seconds) to indicate the number of House Coded units in the system

Duration of House Code Mode: 30 minutes

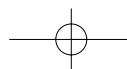

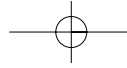

Clearing House Codes: The House Codes memorised can be deleted (i.e. the *RadioLINK* Bases can be uncoded) by pressing and holding the House Code switch on for about 6 seconds. The amber light comes on solidly, then flashes rapidly and stops. Release the House Code switch. The *RadioLINK* Base has now been returned to the default factory setting.

All Ei168RC Bases are set as “Repeater” Bases as standard. The function of a Repeater Base is to receive and then re-transmit the RF signals. This provides multiple possible signal paths to give increased reliability. A maximum of ten *RadioLINK* Bases can be set as Repeaters in any one system.

De-activating the Repeater function:

Press and hold the test button on the alarm until it sounds and the amber light on the side of the *RadioLINK* base illuminates. Immediately (while amber light is still on) press and hold the House Code switch on the side of the *RadioLINK* Base with a small screwdriver until the amber light starts to flash slowly. Release the switch. The amber light will flash slowly a total of **four** times and then stop. This indicates that the Repeater mode has been deactivated.

Re-activating the Repeater function:

Press and hold the test button on the alarm until it sounds and the amber light on the side of the *RadioLINK* base illuminates. Immediately (while amber light is still on) press and hold the House Code switch on the side of the *RadioLINK* Base with

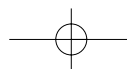

a small screwdriver until the amber light starts to flash slowly. Release the switch. The amber light will flash slowly a total of **sixteen** times and then stop. This indicates that the Repeater mode has been re-activated.

11. *RadioLINK* ACCESSORIES

Ei411H - *RadioLINK* REMOTE SYSTEM CONTROL

This wall mounted device allows you to **Locate**, **Hush** and **Test** RadioLINK Bases with Ei161RC, 164RC or 166RC only alarms fitted. It also has a Locate Memory function that allows the alarm that had previously triggered the system to be identified - a useful troubleshooting feature. (This device must **not** be used with Ei141, Ei144 & Ei146 alarms attached to Ei168RC Bases).



Ei428 - *RadioLINK* RELAY MODULE

This module is a device that switches an internal relay upon receipt of an alarm signal from a RadioLINK device - useful for signalling to panels, turning on strobes etc.



Ei407 - *RadioLINK* MANUAL CALL POINT

This wall mounted call point, when activated, will alarm all Smoke/Heat Alarms mounted on Ei168RC RadioLINK Bases.



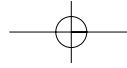

The crossed out wheellie bin symbol that is on your product indicates that this product should not be disposed of via the normal household waste stream. Proper disposal will prevent possible harm to the environment or to human health. When disposing of this product please separate it from other waste streams to ensure that it can be recycled in an environmentally sound manner. For more details on collection and proper disposal, please contact your local government office or the retailer where you purchased this product.

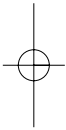

0889

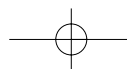
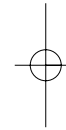

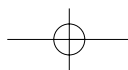
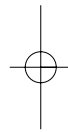
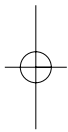
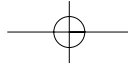

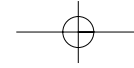

Aico Ltd

Mile End Business Park,
Maesbury Road, Oswestry,
Shropshire SY10 8NN, U.K.
Telephone: 0870 7584000

www.aico.co.uk

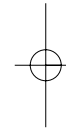
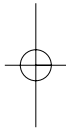

Ei Electronics

Shannon Industrial Estate,
Shannon, Co. Clare, Ireland.
Telephone: +353 (0)61 471277

www.eielectronics.com

