

# EEC10(EU)

## Feature

- Supply Voltage:220-240VAC 50/60Hz
- Insulation Class: II
- Ingress Protection:IP20
- Emergency Duration: 3hours/2hours
- Battery Recharge Time: 24h
- Max Battery Temperature:60°C
- Ambient Temperature:0-40°C
- Charge indicator:Green LED
- Deep Discharge Protection DDP
- Assembly indoors to flat surface
- Non-maintained Operation

## Description

Item Code	Batteries	LED	Power	Lumen	Emergency time	Mode
EEC10-S10-1W	LiFePO4	3535	1W	135lm	3h	Open Area
EEC10-S1C-1W	3.2V 1500mAh	3535	1W	135lm	3h	Corridor
EEC10-S10-3W	LiFePO4	5050	3W	300lm	3h	Open Area
EEC10-S1C-3W	6.4V 1500mAh	5050	3W	300lm	3h	Corridor

- 1.All specifications are typical on the 230VAC unless otherwise stated.
- 2.The emergency function test must be performed when a battery is fully charged for 16 hours.
- 3.Do stocking:The best charging time will be once in 6 months with 24 hours for each time.

## Important:

It is recommended that the unit is installed by a competent person ensuring the installation complies with the necessary standards.  
The company accept no responsibility for incorrect installation, operation or maintenance.  
After installation of the fitting, the battery must be charged for 24 hours.

220-240V  
AC  
50/60Hz

LED

IP20



LiFePO4

## Dimensions

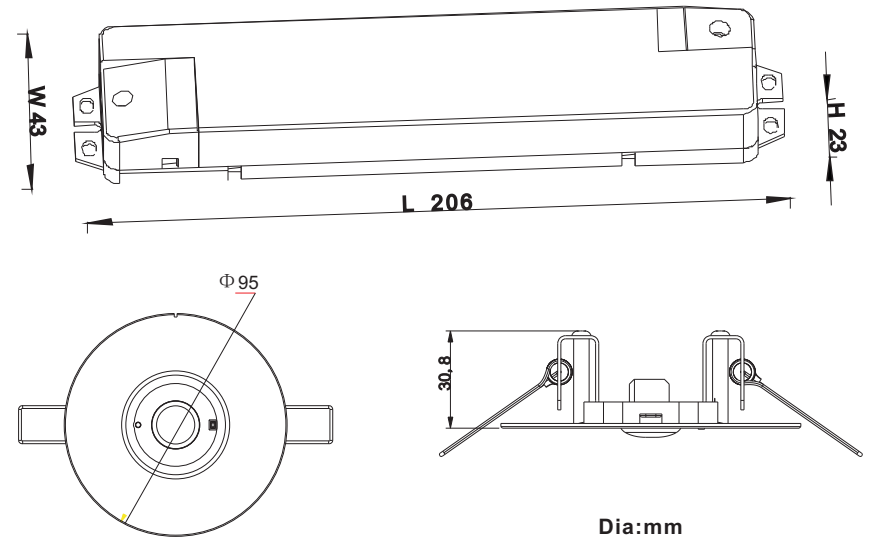

## Connections

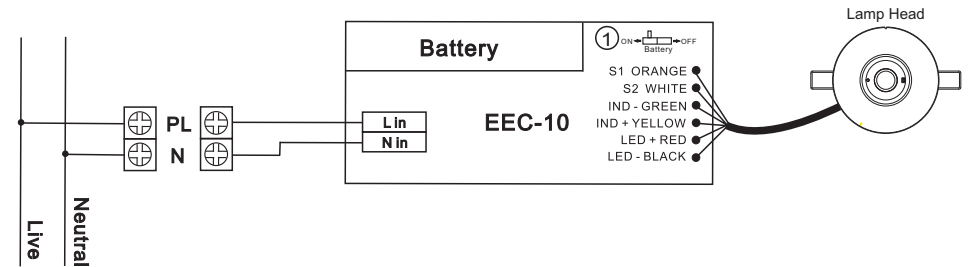

- ① Re-set Plug: "OFF" Battery is disconnected with the Emergency converter  
"On" Battery is connected with the Emergency converter

## Mounting Accessories

### Item Code

MD-EEC10-S10

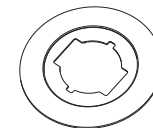

## Mounting Options

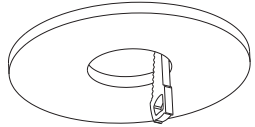

Step1 : Drill a hole on False ceiling  
(Hole's Dia is 70-145mm)

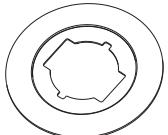

accessory

If the size for hole is within the range of 91-145mm, it is necessary to add a extra bigger ring. Add accessory as below:

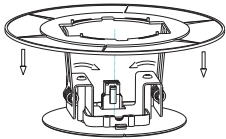

Fix the springs into the big ring follows the picture.

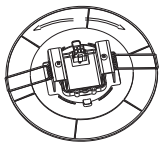

Adjust the lamp head with the right position.

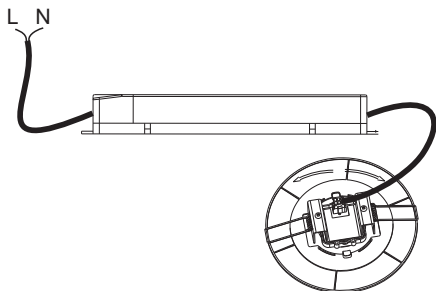

Step2:Wiring

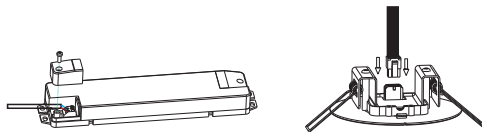

Step3:Put the driver into the false ceiling through the hole first.

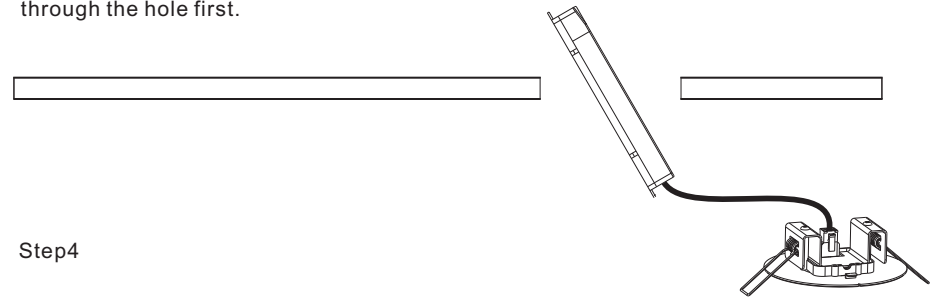

Step4

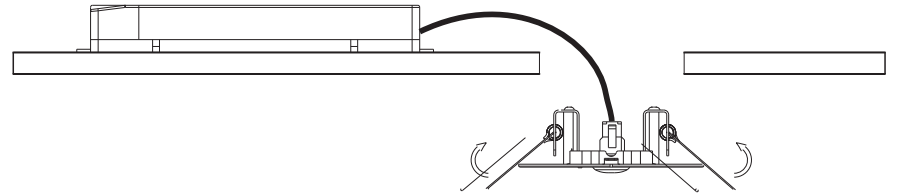

Step5

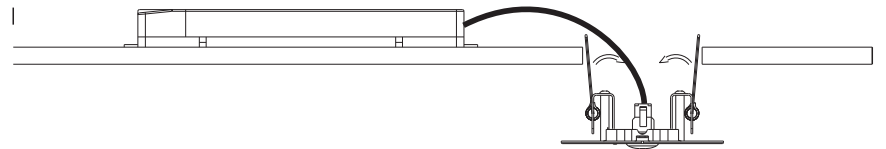

Finished.

## Additional guidelines

Ensure correct polarity of the battery  
The drawing in the fitting may vary to the actual product, connect as per label on fitting.  
Building insulation may affect the sides of the luminaire, is ok for the product.  
When fitting a flush fitting, refer to installation instruction, including any ceiling manufacturer's instructions.