



Nest Protect™ (Wired 230 V ~ 50 Hz)
Detects smoke and carbon monoxide (CO)

User's Guide

ATTENTION: Please read carefully, and keep this user's guide in a safe place.

First, a word about privacy.

We're committed to being open and honest about how we use data. We will always ask for permission before sharing personally identifiable information like your email address, and we keep your data safe with the same security tools that banks use. Go to [**nest.com/eu/privacy**](https://nest.com/eu/privacy) to learn more about our Privacy Policy.

TABLE OF CONTENTS

Meet your Nest Protect	4
Setup and installation	6
Location in your home	8
Placement on the ceiling or wall	10
Heads-Up and Emergency Alarms	16
Daily Use and Emergency Preparation	18
General Maintenance	20
Safety	24
Limited Warranty	35

Want to see how it's done? Go to nest.com/eu/installprotect for installation videos and tips.



MEET YOUR NEST PROTECT

Nest Protect is designed to detect smoke and carbon monoxide in a residential environment. It has multiple sensors to help it understand what's happening in your home, including a Split-spectrum Sensor to detect a wide range of slow-smouldering and fast-flaming fires.

The installation of this apparatus should be carried out by a competent person. This guide covers the installation of Nest Protect (Wired 230 V) – model number A14.

REQUIREMENTS

You need Wi-Fi, an iOS or Android phone or tablet and a free Nest Account in order to use some Nest Protect features: spoken room names, wireless mobile notifications and software updates. During setup, Wi-Fi and a free Nest Account are required for wireless interconnect and room naming. After all the Nest Protects in your home are connected, they can communicate with each other without Wi-Fi.

Inside the box, you'll find:



Nest Protect



Back plate



4 mounting screws



3 connector blocks



230 V AC connector

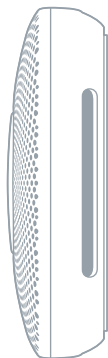

13.5 cm
(5.3 in)

3.9 cm
(1.5 in)



The siren enables Nest Protect to alert you with a loud emergency sound.

The speaker allows Nest Protect to speak with a human voice.

The light ring changes colour to alert you.

Push the Nest button to silence alarms or run a test.

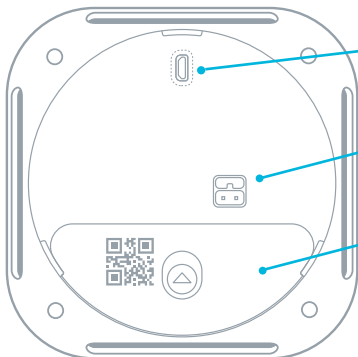

Micro-USB connector (not for normal use).

AC connector pins for the 230 V connector.

Backup battery compartment: Three AA Energizer® Ultimate Lithium batteries (L91).

SETUP AND INSTALLATION

(Professional installation recommended)

The installation of a smoke/CO alarm should be made by a qualified technician, and all wiring used to install this alarm should be made in accordance with with national regulations. Installation should be done according to regulations and/or applicable codes in your local jurisdiction. Permanent connection to the fixed wiring of the building should be made in a suitable junction box.

For a complete set of instructions and warnings, refer to page 24.

1. Get the Nest app

Before you install your Nest Protect on the ceiling or wall, you'll need to set it up with the Nest app. Download the app from the Apple App Store™ or Google Play™ and create a free Nest Account. You can use a phone or tablet for setup.



2. Set up Nest Protect

The Nest app will guide you through each step: scanning the Nest Protect QR code, connecting it to the Internet and connecting it to other Nest Protects in your home. Go to nest.com/eu/installprotect to watch the video.

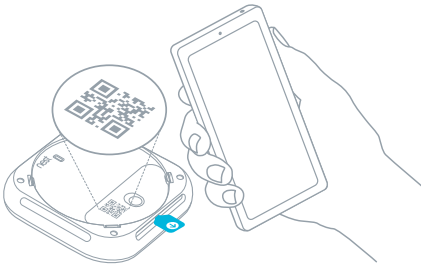

Tip: Set everything out on a table for easy setup.

3. Have more Nest Protects?

The Nest app will ask you if you have additional Nest Protects to set up. If you do, it'll take you through a faster setup. Make sure that you keep all your Nest Protects together until they're all set up and ready to be installed.

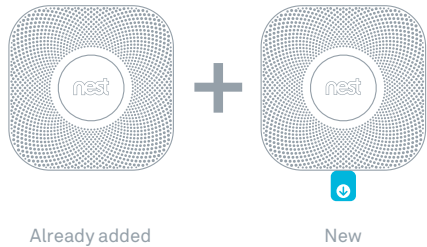

Tip: Your Nest Protect came packed in a plastic cover. Keep the cover on so that your Nest Protect stays clean until you install it.

Location in your home

We recommend placing a smoke alarm on every floor and a carbon monoxide alarm in every room containing a fuel-burning appliance.

The Nest Protect smoke and carbon monoxide alarm should be installed:

- On every floor (smoke alarms are required by law in certain residences).
- In every room containing a fuel-burning appliance (recommended for CO alarms).
- In every bedroom.
- In remote rooms that are used often but which may be too far away for anyone to hear an alarm.
- Outside unused rooms, like the boiler room.

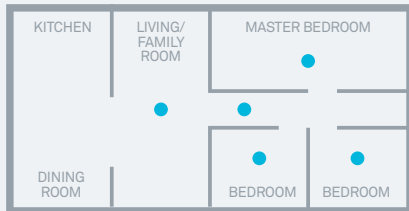

Nest Protect should be installed at least 3 m (10 ft) away from hobs or cooking appliances.

Make sure that there is a clear space around all installed Nest Protects so that they are not obstructed.

Nest Protect should NOT be installed in unfinished attics or garages.

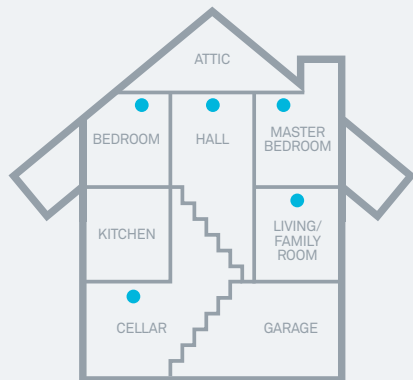

4. Test before you install

Once you've finished setting up all your Nest Protects, make sure that they've been added to your Nest Account. Push the Nest button on one Nest Protect and follow the instructions. All your Nest Protects should speak up. Now you can install them on the ceiling or wall.

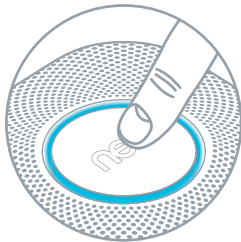

Tip: To double-check Nest Protect's room name, press the Nest button once. You'll hear the location that you assigned to it during setup. It'll say something like, "Ready in the bedroom."

5. Turn off the mains power

Protect yourself, and avoid blowing a fuse. Switch off the correct circuit breaker for the room where you are installing Nest Protect, or remove the fuse from the fuse box.



Fuse box



WARNING

ELECTRICAL SHOCK HAZARD

Failure to turn off the power may result in serious electric shock, injury and death.

Placement on the ceiling or wall

Installation on the ceiling is recommended. Use the back plate as a guide to mark where the screws will go. Make sure that it's at least 30 cm (12 inches) away from the wall.

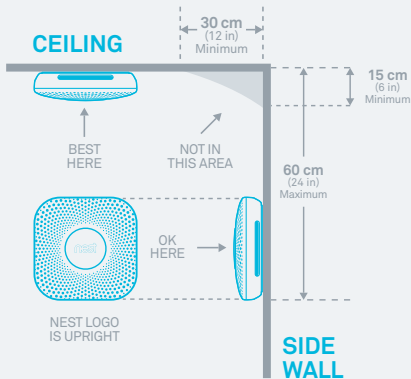

Figure 1

Placement on a sloping ceiling

If you have a sloping, pitched or cathedral ceiling, Nest Protect should be 90 cm (35 inches) from the highest peak.

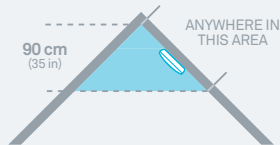

Figure 2

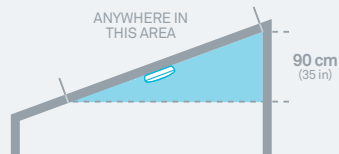

Figure 3

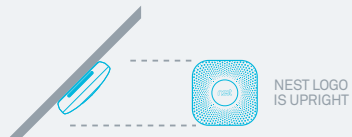
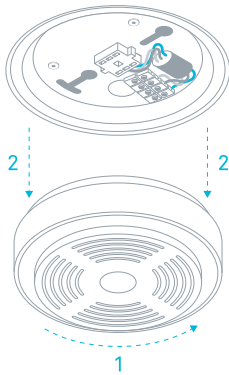

Figure 4

6. Remove your old smoke alarm

To prevent electric shock, make sure that the green power light is off on the alarm. You may have to twist the alarm to release it. Remove it carefully to avoid damaging your ceiling or wall. There will be two or four wires attached to the old back plate. Disconnect them all.



Tip: Your old smoke alarm might make a loud noise when you disconnect it.

7. Remove the old back plate

Unscrew the back plate from the ceiling or dry lining box. Save the screws for installing the Nest back plate later. You'll see one or two cables coming from the ceiling.

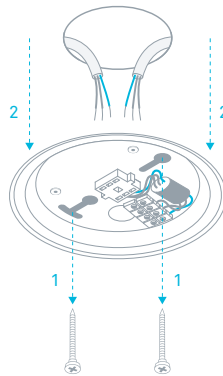

8. Attach the Nest connector

Each cable coming from the ceiling or wall will have three or four differently coloured wires. Their colours may vary based on their age.

Live wire (brown or marked L)



Neutral wire (blue or marked N)



Earth wire (yellow and green), if present



Interconnect wire (usually black), if present

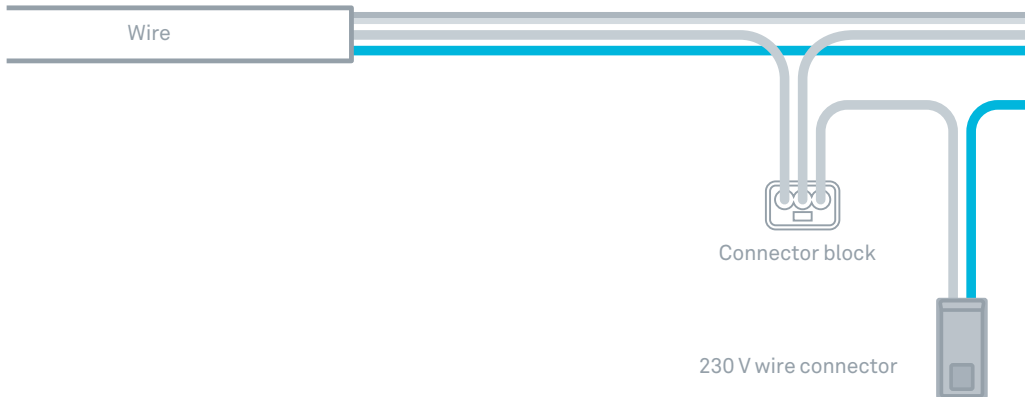

Match the live wires coming from the ceiling to the live wires in the Nest 230 V AC connector and put them into a connector block. All the neutral wires go into another connector block, and the earth wires into a third terminal block. There is no need for the Interconnect wire, as Nest Protects are wirelessly interconnected. If there's an interconnect wire, insulate it.

▲ WARNING

Mixing the live and neutral connections when connecting alarms will damage all the alarms – ensure that the same colours are used throughout the premises for live, neutral and interconnect wires (if present).

Connector block

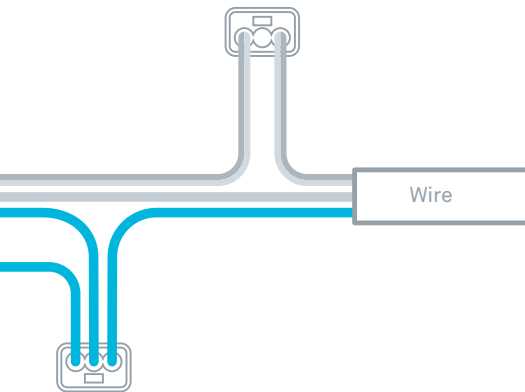

Connector block

9. Install the Nest back plate

Screw the Nest back plate to the existing electrical box, reusing the existing screws. You can also screw the back plate directly into the wall or ceiling with the Nest screws.

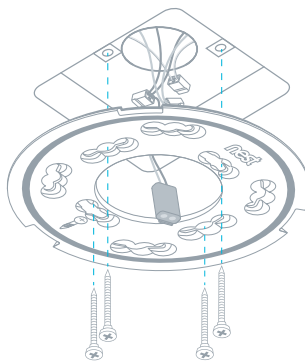

Tip: All smoke alarms prefer to live in a dust-free area, so remove any dust before you install Nest Protect.

10. Connect power

Plug the 230 V connector into the back of your Nest Protect.

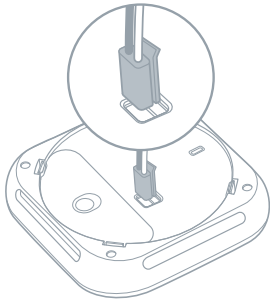

11. Install your Nest Protect

Tuck any excess wiring into the dry lining box first. Line up the three tabs on the back of your Nest Protect with the notches on the back plate. Hold Nest Protect against the back plate and turn it clockwise. Continue turning until it's square with the wall or ceiling. Install the rest of your Nest Protects if you have more.

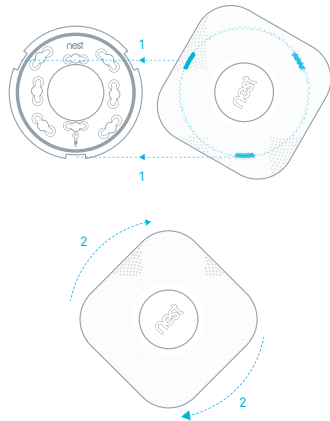

Tip: If you ever need to remove it (for cleaning or battery replacement), turn off power to your Nest Protect at the fuse box or remove the fuse first. Then turn it anticlockwise until it disconnects from the back plate.

12. Switch mains power back on or replace the fuse



Fuse box

13. Press to test

Press the Nest button on one Nest Protect. It will tell you what to do next. Every Nest Protect in the house should speak up, confirming that they're connected to each other.

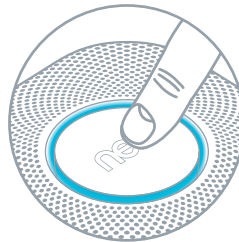

HEADS-UP AND EMERGENCY ALARMS

ALERTS

When Nest Protect has something to say, it will speak to you and light up instead of just beeping. Nest Protect has two kinds of voice alert: Heads-Up and Emergency Alarm.

When smoke or carbon monoxide levels are heightened but haven't yet reached Emergency Alarm levels, Nest Protect can sound a Heads-Up as an early warning. Nest Protect will pulse yellow and tell you where there's smoke or carbon monoxide.

You'll get an Emergency Alarm when smoke or carbon monoxide reach critical levels. Nest Protect will pulse red, tell you what room the emergency is in and sound a loud alarm. If there's both smoke and CO present, the smoke alarm will take priority.

SILENCING

Heads-Up alerts and Emergency Alarms can be silenced by using the Nest app or pressing the Nest button. Only silence an alarm once you have checked conditions at the Nest Protect that first sounded the alarm. Do not silence Nest Protect by disconnecting it from mains voltage and removing the batteries. This will disable the alarm so that it cannot sense smoke or carbon monoxide, leaving you at risk.







Because there are many different types of fire, you may experience an Emergency Alarm without having first having experienced a Heads-Up alert. This means that critical levels of smoke or CO occurred extremely quickly and Nest Protect had to sound the Emergency Alarm.

HAVE MORE THAN ONE NEST PROTECT?

After all the Nest Protects in your home are connected to each other, if there's a Heads-Up or an Emergency Alarm in one room, they'll all tell you what the danger is and which room it's in.

If multiple Nest Protects are interconnected, a Heads-Up alert or Emergency Alarm can be silenced only at the Nest Protect that originally sounded the alert. You'll need to go to that room to silence all the Nest Protects in your home. Always check the conditions near the Nest Protect that first detected the smoke or carbon monoxide before silencing it.

HEADS-UP AND EMERGENCY ALARMS

	WHAT YOU HEAR	WHAT YOU SEE	WHAT IT MEANS	WHAT TO DO
ALERTS	"PLEASE BE AWARE. THERE'S SMOKE IN THE [ROOM NAME]. THE ALARM MAY SOUND."	 YELLOW pulses.	Smoke levels are rising.	Put out the source of the smoke. Then use the Nest app or press the Nest button to silence the alert.
	"PLEASE BE AWARE. THERE'S CARBON MONOXIDE IN THE [ROOM NAME]. THE ALARM MAY SOUND."	 YELLOW pulses.	Carbon monoxide levels have been high for a while.	Open a window or door to get fresh air. Then use the Nest app or press the Nest button to silence the alert.
	(Alarm siren) "EMERGENCY. THERE'S SMOKE IN THE [ROOM NAME]."	 RED pulses.	The smoke in the room has reached critical levels.	Get out of the house immediately.
	(Alarm siren) "EMERGENCY. THERE'S CARBON MONOXIDE IN THE [ROOM NAME]. MOVE TO FRESH AIR."	 RED pulses.	The carbon monoxide in the room has reached critical levels.	<ol style="list-style-type: none">1) Keep calm and open all doors and windows.2) Stop using all fuel-burning appliances and ensure that they are turned off.3) Evacuate the premises if the CO alarm continues to sound.4) Call 999 or the fire brigade from outside.
SILENCING	"SMOKE ALARM SILENCED."	 YELLOW or RED pulses.	You've silenced an alert. Nest Protect will now keep quiet, unless smoke or carbon monoxide remains at critical levels.	Make sure you're safe and have put out the source of smoke or carbon monoxide.
	"CARBON MONOXIDE ALARM SILENCED."			
	"THE ALARM IS OVER."	 GREEN pulses.	Smoke or carbon monoxide levels are decreasing.	Make sure you're safe and have put out the source of smoke or carbon monoxide.

DAILY USE AND EMERGENCY PREPARATION

DAILY USE

POWER

Nest Protect (Wired 230 V) has a small green light located at the top of the Nest button. It will be on as long as Nest Protect is getting AC power from the electrical wires.

If there's a wiring problem or power cut, the green light will turn off and Nest Protect will switch to backup batteries. You'll also see a yellow (instead of green) Nightly Promise light when you turn off the lights for the night.

NIGHTLY PROMISE

Nest Protect continuously tests itself, so you don't have to wonder if it's working. Nightly Promise reports on every Nest Protect in your home.

When you turn off the lights for the night, Nest Protect will glow green for a moment – this means that everything is working. If it glows yellow, one of the Nest Protects in your home needs your attention. For instance, the batteries are low, Wi-Fi is down or there's a problem with the sensors. Just push the Nest button or use the Nest app to see what's wrong.

PATHLIGHT

Nest Protect usually has its light turned off, but it can light your way as you walk underneath it in the dark. You can enable or disable Pathlight and set its brightness with the Nest app.

Nest Protect (Wired 230 V) also allows you to set Pathlight to “Always On” if you want a night light. It will turn on when it's dark and stay on until it's light again.

EMERGENCY PREPARATION

TESTING





We recommend running a weekly manual test. During a test, all interconnected Nest Protects in your home check their sensors, power, Wi-Fi connection, emergency siren, speaker and microphone.

When you run a test, Nest Protect will give you a countdown before sounding the alarm so that you have time to move away from the loud noise.

Test procedure:

1. Start a test by pressing the Nest button twice.
2. Nest Protect will say: “This is only a test. The alarm will sound.”
3. Ensure that the alarm sounds and the light illuminates on each Nest Protect.
4. Once the Nest Protect has made sure it's working, it'll tell you that everything's OK. If you have interconnected Nest Protects, all of them should speak.

DAILY USE AND EMERGENCY PREPARATION

	WHAT YOU HEAR	WHAT YOU SEE	WHAT IT MEANS	WHAT TO DO
DAILY USE		 GREEN light above the Nest logo.	Nest Protect is working. The green light means AC power is connected.	
		 You turn off the room lights for the night, and the GREEN light pulses once.	Nest Protect has tested its sensors and batteries to confirm that they are working correctly.	Sleep well, thanks to Nightly Promise.
		 WHITE light.	Pathlight lights your way at night as you pass under it. It can also be set to stay on.	
EMERGENCY PREPARATION	"READY. PRESS TO TEST."	 BLUE rotates.	To set up or run a manual test.	Press the Nest button. Nest Protect will walk you through the next steps.

▲ WARNING

- DO NOT stand close to the alarm when the siren is sounding. Exposure at close range may be harmful to your hearing. When testing, move away before the siren starts sounding.
- If the alarm ever fails to test correctly, have it replaced immediately! If the alarm is not working properly, it cannot alert you to a problem.
- DO NOT use a match, cigarette or any other makeshift fire to test the smoke alarm.
- NEVER use vehicle exhaust to test the CO alarm! Exhaust may cause permanent damage and will void your warranty.
- NEVER use an open flame of any kind to test this alarm. You might accidentally damage or set fire to the unit or to your home.

GENERAL MAINTENANCE

CLEANING YOUR NEST PROTECT

Nest Protect has been designed to be as maintenance free as possible, but you should keep it clean. As with any smoke alarm, dust build-up on the outside or inside of Nest Protect can stop it from working properly.

To clean Nest Protect:

1. Turn off mains power to Nest Protect or remove the fuse (see p.9).
2. Remove it from the wall or the ceiling (turn anticlockwise until it comes off the back plate and detach the power connector).
3. Wipe the outside with a clean, slightly damp cloth. Don't use soap or solvents.
4. Place Nest Protect on a soft, dry cloth with the Nest button facing down. Open the battery compartment door and remove the batteries. Remove the screws and lift off the back. Be careful not to lose the screws.
5. Gently vacuum the inside. Make sure that you clean all the way around the mesh sides of the smoke chamber (the large metal circle).

Note: Never use detergents or solvents (like glass cleaner) on your Nest Protect, and do not spray air fresheners, hair spray or other aerosols near it. Do not get water inside the alarm or paint over it.

REPLACING THE BACKUP BATTERIES

If there is a power cut, Nest Protect will use three AA Energizer® Ultimate Lithium batteries (L91) for backup. These batteries can be purchased at your local retailer.

1. Turn off mains power to Nest Protect or remove the fuse (see p.9).

2. Twist Nest Protect anticlockwise until it disconnects from the back plate.
3. Detach the power connector from the back of Nest Protect and open the battery door.







4. Replace the batteries. Align the + positive and - negative ends with the markings in the battery compartment.
5. Close the battery compartment. Do not force the door closed.
6. Re-attach the power connector.
7. Push Nest Protect onto the back plate and turn it clockwise until you feel it grip.
8. Turn mains power to Nest Protect back on or replace the fuse.
9. Press the Nest button twice.



▲ WARNING

- Only use batteries specified by Nest. Use of a different battery model will have a detrimental effect on the operation of the smoke alarm. The alarm may not operate properly with other batteries. Never use rechargeable batteries, as they may not provide a constant charge.
- Never remove the batteries from a battery-operated alarm to stop an unwanted alarm (caused by cooking smoke, etc.). Removing batteries disables the alarm so that it cannot sense smoke or carbon monoxide, leaving you at risk.

GENERAL MAINTENANCE

	WHAT YOU HEAR	WHAT YOU SEE	WHAT IT MEANS	WHAT TO DO
GENERAL MAINTENANCE	"THE SENSORS HAVE FAILED IN THE [ROOM NAME]. REPLACE NEST PROTECT NOW." Single chirp every 60 seconds.	 YELLOW pulses.	Nest Protect has tested its sensors, and there is a problem.	Clean according to instructions on page 16. If the problem persists, replace Nest Protect.
	"THE BATTERY IS LOW IN THE [ROOM NAME]. REPLACE THE BATTERY SOON."	 YELLOW pulses.	Low battery.	Change Nest Protect's batteries soon.
	"THE BATTERY IS LOW IN THE [ROOM NAME]. REPLACE THE BATTERY NOW." Single chirp every 60 seconds.	 YELLOW pulses.	Low battery.	Change Nest Protect's batteries now.
	"NEST PROTECT CANNOT SOUND THE ALARM IN THE [ROOM NAME]." Two chirps every 60 seconds.	 YELLOW pulses.	There's a problem with Nest Protect's siren.	Replace Nest Protect now.
	"NEST PROTECT HAS EXPIRED. REPLACE NEST PROTECT NOW." Two chirps every 60 seconds.	 YELLOW pulses.	Nest Protect has expired and reached the end of its life.	Replace Nest Protect now.

▲ WARNING

- The alarm will not operate without battery power. The alarm cannot work until you install the batteries in the correct position (Match + to +, and - to -).
- This device contains lithium batteries. If

- tampered with, the battery may be short circuited and create a risk of fire. Never attempt to open or damage the alarm.
- Replace all batteries at once and only use new, unused batteries as replacements.

GENERAL MAINTENANCE

SERVICING

1. Before sending Nest Protect for service, visit nest.com/eu/support
2. If your Nest Protect needs servicing, contact our Support team first to get a returns number
3. Send your Nest Protect to:

Nest Labs

(YOUR RETURN NUMBER)

Arvato Distribution GmbH – Technology
Willi-Bleicher-Str. 36
52353 Düren
Germany

EXPIRY

Like any smoke and CO alarm, Nest Protect has a limited life. You will need to replace Nest Protect after 10 years with a brand-new Nest Protect. You can check the replacement date written on the back of Nest Protect to see when it will expire.

About two weeks before it expires, Nest Protect will light up with a yellow light. Press the Nest button and it will say, “Nest Protect has expired. Replace it now.” Buy a new alarm and recycle the expired one. Make sure that you test your new Nest Protect once it’s installed.

RECYCLING AND DISPOSAL

Nest recognises its responsibility to minimise the environmental impact of its operations and products. Once Nest Protect has expired, you will need to recycle it according to local regulations. Please visit nest.com/eu/recycle to learn more about Nest’s commitment to environmental responsibility and to find where you can safely recycle your Nest Protect.



The WEEE symbol means that your product should be disposed of separately from general household waste, in accordance with local laws and regulations. When Nest Protect reaches the end of its life, take it to a collection point designated by your local authority. Some collection points accept products free of charge. The separate collection and recycling of your product will help conserve natural resources and ensure that it is recycled in a manner that protects human health and the environment.

RESETTING NEST PROTECT

You can reset Nest Protect to erase all your settings and reset the wireless interconnection with other Nest Protects. You may want to do this when you move to a new home. Follow the steps below on each Nest Protect that you want to reset.

1. Press and hold the Nest button. Nest will chime and glow blue.
2. Keep holding the button until Nest Protect begins to say its version number. Then release the button.
3. Nest Protect will start a verbal countdown and tell you that it’s erasing all settings. You can cancel the reset by pressing the Nest button during the countdown.
4. It will restart after a few seconds.

Your Nest Protect will still detect smoke and carbon monoxide after being reset. Go to nest.com/eu/protect/reset for complete reset instructions.

TECHNICAL SPECIFICATIONS

- Temperature range: 4 °C (40 °F) to 38 °C (100 °F).
- Humidity range: 20% RH to 80% RH (non-condensing).

WIRELESS INTERCONNECT

Nest Protects connect wirelessly to each other so that when one speaks, they all speak. This means that when one Nest Protect raises any kind of alert, every Nest Protect in the house will tell you which room the smoke or CO is in. For example, if you're in the bedroom and the alarm goes off in the basement, the Nest Protect in the bedroom will tell you where the smoke or CO is. To silence the alert, go to the room where the alarm was triggered. All the Nest Protects in the house can be silenced from there. Either press the button on the Nest Protect or use the Nest app to silence the alarm.

Nest Protect does not have a wire for interconnect because it connects wirelessly. There's no need to connect any Nest Protect wire to the interconnect wire coming from the ceiling or wall.

Nest Protect - Wired 230 V (model numbers 05C-E and A14) and Nest Protect - Battery (model numbers 05A-E and A13) are compatible and can be interconnected wirelessly. Nest Protect wireless interconnect will not work with smoke or CO alarms from other brands.

Nest Protects can generally communicate with each other if they're 15 m (50 feet) or less apart inside a home. Some features of a home may reduce Nest Protect's wireless interconnect range, including the number of floors, number and size of rooms, furniture, type of building materials, suspended ceilings, ductwork, large metal appliances and metal studs. This kind of interference can be overcome by adding more Nest Protects that can route wireless signals around obstructions.

▲ WARNING

- The range and proper operation of any wireless device will vary depending on its surroundings.
- Nest Protect alarms are not to be used outdoors or to transmit between buildings. The alarms will not communicate properly in those conditions.
- Metal objects and metallic wallpaper may interfere with signals from wireless alarms. Test your Nest Protects with metal doors opened and closed.

Note: Nest Protect can be used as a single-station or multiple-station alarm. You can connect up to 18 interconnected Nest Protects to your Nest Account.

SAFETY

ALARM LIMITATIONS

LIMITATIONS OF SMOKE ALARMS

Alarms reduce deaths resulting from house fires worldwide. However smoke alarms can only work if they are properly located, installed and maintained, and if smoke reaches the alarms.

- Smoke alarms may not wake all individuals. Make sure that you create an escape plan and that you practise fire drills with all members of the family.
- Smoke alarms cannot work without power. If they are powered by batteries, the smoke alarms cannot work if the batteries are missing, dead or disconnected. If they are wired, the smoke alarms cannot work during a long power cut and once the backup battery is dead. Nest Protect will warn you in advance when batteries are running low so that you can replace them.
- Smoke will not be able to reach the smoke sensor while the dust cover is in place. The dust cover must be removed.
- Smoke alarms cannot detect fires if the smoke does not reach the alarms. For example, if a door is closed, smoke may not reach the smoke alarm. This is why you should have a smoke alarm in each bedroom and in the hallways, as bedroom doors may be closed at night.
- Smoke alarms may not be heard. Although the smoke alarm comes with a loud, 85-decibel siren, it may not be heard if: 1) people have consumed alcohol or drugs, 2) the alarm is drowned out by noise from stereos, TVs, traffic, air conditioners or other appliances, 3) residents are hearing impaired or have high-frequency hearing loss associated with ageing. Special smoke alarms should be installed for those who are hearing impaired.

- This smoke alarm is not intended to alert hearing-impaired residents. Alarms specifically designed for the hearing impaired, which feature devices like flashing strobe lights or low-frequency devices, are available to alert the hearing impaired in case of fire.
- This smoke alarm alone is not a suitable substitute for complete fire detection systems in places housing many people – such as blocks of flats, condominiums, hotels, motels, dormitories, hospitals, long-term health-care facilities, nursing homes, day-care facilities or group homes of any kind – even if they were once family homes. It is not a suitable substitute for complete fire detection systems in warehouses, industrial facilities, commercial buildings and special-purpose non-residential buildings, which require special fire detection and alarm systems. Depending on the building codes in your area, this smoke alarm may be used to provide additional protection in these facilities.

LIMITATIONS OF CARBON MONOXIDE (CO) ALARMS

- NEVER ignore your carbon monoxide alarm if it goes off. Refer to “What to do in case of a carbon monoxide alarm” for more information. Failure to do so can result in injury or death.
- This CO alarm is designed for use inside a family home or flat. It is not meant to be used in common lobbies, hallways or basements of blocks of flats unless working CO alarms are also installed in each family living unit. CO alarms in common areas may not be heard from inside individual family living units.
- This CO alarm alone is not a suitable substitute for complete detection systems in places that house many people, like hotels or dormitories, unless a CO alarm is also placed in each unit.
- DO NOT use this CO alarm in warehouses, industrial or commercial buildings, special-purpose non-residential buildings or aircraft. This CO alarm is specifically designed for residential use and may not provide adequate protection in non-residential applications.
- Some individuals are more sensitive to CO than others, including people with cardiac or respiratory problems, infants, unborn babies, pregnant mothers or elderly people, who can be more quickly and severely affected by CO. Members of sensitive populations should consult their doctors for advice on taking additional precautions.
- The silence feature is for your convenience only and will not correct a CO problem. Always check your home for a potential problem after any alarm. Failure to do so can result in injury or death.

INSTALLATION CODE

Specific requirements for smoke alarm installation vary from country to country, and from region to region. Check with your local Fire Service for current requirements in your area.

▲ WARNING

Smoke alarms are designed to alert you with an audible alarm at a level specified by EN 14604:2005.

▲ WARNING

The smoke alarm accompanying this user's guide employs the latest technology and is independently tested as being compliant with guidelines established by the European Committee for Standardization (CEN). However, as with any electronic product it may fail and may not sense all types of fire within sufficient time to alert you of the danger and provide adequate time for your escape. In order to maximise your level of safety always test your smoke alarm frequently to ensure it is in full working order.

▲ WARNING

There is a risk of malfunction and electrical shock, if the smoke alarm is tampered with.

Your smoke/CO alarm is only suitable for use in domestic residential applications, as covered in this user's guide. It is not suitable for commercial or industrial applications. It is designed to sense smoke and carbon monoxide, and alert you. It will not prevent or extinguish fires.

WHERE TO INSTALL A SMOKE ALARM

Nest recommends the following installation.

Multi-family or mixed occupant residence (Tenancy building, student accommodation)

Your smoke/CO alarm can also be used in individual flats and bedsits, providing the same conditions are met as for a single-family residence. However, there must already be a primary fire detection system that meets regulatory requirements for common areas such as lobbies and hallways.

Institutions and Hotels

This includes guest houses, hospitals, day-care facilities, long-term health-care facilities, B&Bs and halls of residence. Your smoke/CO alarm can be used in individual sleeping areas/residents' rooms, provided that the same conditions are met as for a family residence. However, there must already be a primary fire detection system that meets regulatory requirements for common areas such as lobbies and hallways. Use of this smoke alarm in common areas may not provide sufficient fire warning to residents or meet regulatory requirements.

Commercial and Industrial Premises

This smoke alarm is not intended for any non-residential, commercial or industrial application, nor for any other purpose than that described above.

SMOKE DETECTION

Are more smoke alarms desirable?

The required number of smoke alarms might not provide reliable early-warning protection for those areas separated by a door from the areas protected by the required smoke alarms. For this reason, the use of additional smoke alarms for those areas is recommended for increased protection. The additional areas include the dining room and hallways not protected by the required smoke alarms. The installation of smoke alarms in kitchens, attics (finished or unfinished) or garages is not normally recommended because these locations occasionally experience conditions that can result in improper operation. As Nest Protect is also a carbon monoxide alarm, we do not recommend installing it in a boiler room or a utility room if it contains a water heater or a boiler. It should be 5–6 m (15–20 ft) from these appliances to avoid transient conditions and/or perceived nuisance alarms.

WHERE NOT TO INSTALL YOUR SMOKE ALARMS

For best performance, AVOID installing a smoke alarm in these areas:

- **Where combustion particles are produced.** Burning material creates combustion particles that could cause your smoke alarm to go off unnecessarily. Areas to avoid include poorly ventilated kitchens, garages, boats, recreational vehicles and boiler rooms. Keep a smoke alarm at least 6 metres (20 feet) from the source of combustion particles (cooker, boiler, water heater, space heater), if possible. In areas where a 6-metre (20-foot) distance is not possible – in mobile or smaller homes, for

example – we recommend placing a smoke alarm as far from these fuel-burning sources as possible. The placement recommendations are intended to keep a smoke detector at a reasonable distance from a fuel-burning source, reducing “unwanted” alarms.

Unwanted alarms can occur if a smoke alarm is placed directly next to a fuel-burning source. Ventilate these areas as much as possible.

- **In air streams near kitchens.** Air currents can draw cooking smoke into the sensor of a smoke alarm near the kitchen.
- **In very damp, humid or steamy areas, or very near bathrooms with showers.** Keep a smoke alarm at least 3 metres (10 feet) away from showers, saunas, dishwashers, etc.
- **Where temperatures are regularly below 4 °C (40 °F) or above 38 °C (100 °F),** including unheated buildings, outdoor rooms, porches, or unfinished attics or cellars.
- **In very dusty, dirty, or greasy areas.** Do not install a smoke alarm directly over the cooker or range. Clean a laundry room unit frequently to keep it free of dust or lint.
- **Near fresh air vents, ceiling fans, or in very drafty areas.** Drafts can blow smoke away from a smoke alarm, preventing it from reaching the sensor.
- **In insect-infested areas.** Insects can clog openings to the sensor and cause unwanted alarms.
- **Less than 30.5 cm (12 in) away from fluorescent lights.** Electrical “noise” can interfere with the sensor.
- **In “dead-air” spaces.** “Dead-air” spaces may prevent smoke from reaching a smoke alarm.

AC INSTALLATION WARNINGS

WHERE NOT TO INSTALL YOUR CARBON MONOXIDE ALARMS

- Keep the carbon monoxide alarm at least 3 m (10 ft) away from any cooking appliances, including the hob, oven, microwave, etc.
- This alarm should not be installed in locations where the temperature is below 4 °C (40 °F) or above 38 °C (100 °F)
- In an enclosed space (for example, in a cupboard or behind a curtain)
- Where it can be obstructed (for example, by furniture)
- Directly above a sink
- Next to a door or window
- Next to an extractor fan
- Next to an air vent or other similar ventilation openings
- Where dirt and dust may block the sensor
- In a damp or humid location

EXAMPLES OF WHEN YOUR SMOKE ALARM MAY NOT BE EFFECTIVE

Your alarm may not be effective in protecting against fire in certain cases:

- Smoking in bed.
- Leaving children unsupervised.
- Cleaning with flammable liquids, like petrol.
- When someone's clothing is on fire.
- Fires where the smoke is prevented from reaching the alarm due to a closed door or other obstruction.

ELECTRICAL SHOCK HAZARD

- Turn off power to the area where you will install this unit at the circuit breaker or fuse box before beginning installation. Failure to turn off the power before installation may result in serious electrical shock, injury or death.
- Do not restore power until all alarms are completely installed. Restoring power before installation is complete may result in serious electrical shock, injury or death.
- Turn off the power to the area where the alarm is installed before removing it from the mounting bracket. Failure to turn off the power first may result in serious electrical shock, injury or death.
- If any unit in the series does not alarm, TURN OFF POWER and recheck connections. If it does not alarm when you restore power, replace it immediately.
- Attempting to disconnect the power connector from the unit when the power is on may result in electrical shock, serious injury or death.
- Failure to meet any of the above requirements could damage the units and cause them to malfunction, removing your protection.
- Improper wiring of the power connector or the wiring leading to the power connector will cause damage to the alarm and may lead to a non-functioning alarm.
- This unit must be powered by a 24-hour, 230 V AC pure sine wave, 50Hz circuit. Be sure the circuit cannot be turned off by a switch, dimmer, or ground fault circuit interrupter. Failure to connect this unit to a 24-hour circuit may prevent it from providing constant protection.

- The alarm cannot be operated from power derived from a square wave, modified square wave or modified sine wave, inverter. These types of inverters are sometimes used to supply power to the structure in off grid installations, such as solar or wind derived power sources. These power sources produce high peak voltages that will damage the alarm.
- Never disconnect the power from an AC powered unit to stop an unwanted alarm. Doing so will disable the unit and remove your protection. In the case of a true unwanted alarm open a window or fan the smoke away from the unit. The alarm will reset automatically when it returns to normal operation.
- Improper wiring of the power connector or the wiring leading to the power connector will cause damage to the alarm and may lead to a non-functioning alarm. You must test to ensure proper installation.
- There is a risk of electrical shock, if the smoke alarm is tampered in any way.

INSTALLATION IN IRELAND

REGULATORY REQUIREMENTS

Nest Protect provides both smoke alarm and carbon monoxide alarm functionality. When appropriately installed, Nest Protect will enable you to comply with Irish regulatory requirements.

This document does not purport to provide guidance on legal requirements. For further information about legal requirements in Ireland, you may wish to refer to the relevant legislation, the current edition of the National Rules for Electrical Installations (Wiring Rules), relevant standards and guidance documents.

Smoke alarm requirements

Nest Protect 230 V is suitable for installation in both new and existing buildings. However, battery-powered Nest Protects are not suitable in new buildings or where there is significant construction or change of use taking place. If in doubt, consult a registered electrical contractor.

You should install Nest Protect 230 V to comply with Part B of the Building Regulations and the Technical Guidance document published under Part B. The Part B Technical Guidance requires the provision of a system complying with Part 6 of BS 5839 of 2004 and meeting at least the requirements of a Grade D system, as set out in BS 5839, Part 6. When properly installed, a system comprising Nest Protect 230 V units will meet this standard.

Carbon monoxide alarm requirements

If you are installing a new heat-producing appliance (fire, boiler, etc.) after 1 September 2014, Part J of the Building Regulations will

require the installation of carbon monoxide alarms. While most building regulations apply only where there is new construction, an extension or a significant change of use and only apply to the parts of the building affected, Part J applies whenever a heat-producing appliance is installed or replaced. Carbon Monoxide alarms should be installed in accordance with the technical guidance document for Part J www.environ.ie/en/Publications/DevelopmentandHousing/BuildingStandards/FileDownload,37240,en.pdf

INFORMATION FOR PRO INSTALLERS

Information in this section is intended for registered electrical contractors. It assumes that the reader is familiar with the Wiring Rules and is an Authorised Person, as defined in the Wiring Rules.

Chapter 56 of the Wiring Rules does not apply to domestic and similar premises (see rule 560.2). Accordingly, it is not necessary, among other things, that fire-resistant supply cables be used when installing Nest Protect units.

In existing installations, power supply to each interconnected mains-powered smoke alarm may be derived from a local, frequently used lighting circuit. Accordingly, multiple circuits may supply power to the smoke alarms in a single installation. Ensure that the power supply is disconnected at each such smoke alarm before starting work.

CARBON MONOXIDE (CO) PRECAUTIONS

WHAT IS CARBON MONOXIDE?

Carbon Monoxide (CO) is an invisible, odourless, tasteless gas produced when fuels do not burn completely, or are exposed to heat (usually fire). These fuels include: wood, coal, charcoal, oil, natural gas, gasoline, kerosene and propane.

Common appliances that are often sources of CO include oil or gas burning boilers, gas ovens, wood-burning fireplaces, and charcoal grills. If they are not properly maintained, are improperly ventilated or malfunction, CO levels can rise quickly. Additional sources include space and water heating, cooking, uncontrolled burning, tobacco smoking, internal combustion engine. CO is a real danger now that homes are more energy efficient. “Air-tight” homes with added insulation, sealed windows, and other weatherproofing can “trap” CO inside.

Electrical appliances typically do not produce CO.

Nest Protect will alarm:

- within 3 minutes at 300 ppm CO
- within 40 minutes at 100 ppm CO
- within 90 minutes at 50 ppm CO

Unit will not sound before 120 minutes of exposure at 30 ppm.

SYMPTOMS OF CO POISONING

The following symptoms are related to CARBON MONOXIDE POISONING and are to be discussed with ALL members of the household:

- **Mild Exposure:** Slight headache, nausea, vomiting, fatigue (often described as ‘Flu-like’ symptoms).
- **Medium Exposure:** Severe throbbing headache, drowsiness, confusion, fast heart rate.

- **Extreme Exposure:** Unconsciousness, convulsions, cardiorespiratory failure, death.
- Many cases of reported CARBON MONOXIDE POISONING indicate that while victims are aware they are not well, they become so disoriented that they are unable to save themselves by either exiting the building or calling for assistance. Young children and household pets are usually the first affected.

▲ WARNING

This carbon monoxide alarm is designed to detect carbon monoxide from any source of combustion. It is NOT designed to detect any other gas.

Individuals with certain medical problems should consider using detection devices with lower COHb alarm capabilities and consider warning devices that provide audible and visual signals for carbon monoxide concentrations of under 30 ppm.

Installation of the apparatus should not be used as a substitute for proper installation, use and maintenance of fuel-burning appliances, including appropriate ventilation and exhaust systems.

This apparatus is designed to protect individuals from the acute effects of carbon monoxide exposure. It will not fully safeguard individuals with specific medical conditions. If in doubt, consult your doctor.

WHAT TO DO IN CASE OF A CARBON MONOXIDE ALARM

▲ WARNING

Actuation of your CO alarm indicates the presence of carbon monoxide (CO), which can KILL YOU.

1. Keep calm and open all doors and windows to increase the rate of ventilation.
2. Stop using all fuel-burning appliances and ensure, if possible, that they are turned off.
3. Evacuate the premises if the carbon monoxide alarm continues to sound.
4. Contact your emergency services.

PHONE NUMBER:

5. Get medical help for anyone suffering the effects of carbon monoxide poisoning.
6. Call the appropriate appliance servicing and/or maintenance agency so that the source of the CO emissions can be identified and corrected. Do not use the fuel-burning appliances again until they have been checked and cleared for use by a competent person, according to national regulations.

THE FOLLOWING CONDITIONS CAN RESULT IN TRANSIENT CO SITUATIONS

1. Excessive spillage or reverse venting of fuel-burning appliances caused by:
 - I) Outdoor ambient conditions such as wind direction and/or velocity, including high gusts of wind; heavy air in the vent pipes (cold/humid air with extended periods between cycles).
 - II) Negative pressure differential resulting from the use of exhaust fans.

- III) Simultaneous operation of several fuel-burning appliances competing for limited internal air.
 - IV) Vent pipe connection vibrating loose from clothes dryers, boilers or water heaters.
 - V) Obstructions in, or unconventional vent pipe designs, which amplify the situations above.
2. Extended operation of unvented fuel-burning devices (range, oven, fireplace, etc.).
 3. Temperature inversions that can trap exhaust gases near the ground.
 4. Car idling in an open or closed attached garage, or near a home.
 5. NEVER bring a charcoal barbecue inside, and ALWAYS operate a portable generator outside, a safe distance from the house, and well away from windows.

▲ WARNING

The following substances in high concentration can affect the carbon monoxide sensor and may affect the reliability of the alarm or cause false alarms: paint, thinners, solvents, adhesives, hair sprays, some cleaning agents, ammonia, acetone, hydrogen methane, iso-butane, iso-propanol, ethylene, benzene, toluene, ethyl acetate, alcohol-based products, volatile oils, silicone vapour, hydrogen sulphide, sulphuric acid, hair-grooming products, high concentrations of dust and oil mist, soaking or splashing with water.

FIRE SAFETY PRECAUTIONS

CREATE AN ESCAPE PLAN TO PRACTISE

Be prepared when your smoke/CO alarm sounds its alarm. Develop a family escape plan, discuss it with all household members, and practice it regularly.

- Make sure everyone is familiar with the sound of your smoke/CO alarm and explain what the sound means.
- Determine TWO exits from each room and have an escape route to the outside from each exit.
- Teach all the members in your household to check doors for heat with the back of their hand before opening them and to use the alternative exit if the door is hot. Make sure that they do not open the door if it is hot.
- Teach household members to crawl along the floor to avoid dangerous smoke, fumes and gases.
- Determine a safe meeting place for all household members to regroup at outside the building.

PRACTISE FIRE SAFETY

Practise your escape plan at least twice a year, making sure that everyone is involved – from kids to grandparents. Practise the escape plan with children, including holding one at night when they are sleeping. If children or others do not wake up to the sound of the smoke alarm, or if there are infants or family members with mobility limitations, make sure that someone is assigned to help them for the fire drill and in the event of an emergency.

Current studies have shown that smoke alarms may not wake all sleeping individuals, and that it is the responsibility of individuals in the household who are capable of assisting others to provide assistance to those who may not be woken by the alarm sound, or to those who may be incapable of safely evacuating the area unassisted.

WHAT TO DO IN CASE OF FIRE

- Get out now.
- Don't panic; stay calm.
- Operate your safety plan, as previously planned.
- Alert small children in the home and those who may need extra assistance.
- Leave the building as quickly as possible. Touch doors with the back of your hand and make sure that they are not hot before opening them. Use an alternative exit, if necessary. In case of smoke, crawl along the floor and DO NOT stop to collect anything. Close doors behind you.
- Assemble at a pre-arranged place outside the building.
- Once outside, do a head count and call the fire service.
- DO NOT re-enter the house unless a fire officer says that it's safe to do so.

MOBILE NOTIFICATIONS

▲ WARNING

Nest Protect phone and tablet notifications require a functional Wi-Fi connection. They're only as reliable as your home's Wi-Fi network and aren't a substitute for a third-party emergency monitoring service.

This user's guide and the products described herein are copyrighted, with all rights reserved. Under these copyright laws, no part of this installation guide may be copied for use without the written consent of Nest.

Nest Labs (Europe) Ltd. is a subsidiary of Nest Labs, Inc., a US entity.

Apple and the Apple logo are trademarks of Apple Inc., registered in the US and other countries. App Store is a service mark of Apple Inc. Google Play is a trademark of Google Inc.

EU DECLARATION OF CONFORMITY

We, Nest Labs Inc. declare, under our sole responsibility, that this product complies with the essential requirements of the R&TTE Directive 1999/5/EC, the European Directives 2006/95/EC and 2004/108/EC.

This device meets the following conformance standards: EN 300 328, EN 301 489-1, EN 301 489-17, EN 55022, EN 55024, EN62311, EN61000-3-2 and EN61000-3-3.

Nest Labs Inc. declares that this smoke/CO alarm is in compliance with the essential requirements and other relevant provisions of Directive 1999/5/EC.

A copy of the EU Declaration of Conformity is available at: nest.com/eu/legal/eudoc

CE¹⁵
0843

Nest Labs (Europe) Limited
PO Box 12443
Dublin 2
Ireland
15
0843-CPR-0240
EN 14604:2005
Smoke Alarm Devices
Model number: A14
Technical data : See User's Guide
(64-10-0037-GB)

Nest Labs (Europe) Ltd. Limited Warranty Nest Protect™ smoke and carbon monoxide alarm

THIS LIMITED WARRANTY CONTAINS IMPORTANT INFORMATION ABOUT YOUR RIGHTS AND OBLIGATIONS, AS WELL AS LIMITATIONS AND EXCLUSIONS THAT MAY APPLY TO YOU AS PART OF THE TERMS AND CONDITIONS OF SALE IN EFFECT AT THE TIME THAT YOU PURCHASE A NEST PRODUCT.

YOUR RIGHTS AND THIS LIMITED WARRANTY

This Limited Warranty gives you specific legal rights. You may also have other legal rights that vary by state, province or jurisdiction. For example, these rights may include your rights under the Directive 99/44/EC of the European Parliament on Certain Aspects of Sale of Consumer Goods and Associated Guarantees and other enactments governing the sale of goods. The disclaimers, exclusions and limitations of liability under this Limited Warranty will not apply to the extent prohibited by applicable law. For a full description of your legal rights, you should refer to the laws applicable in your jurisdiction, and you may wish to contact a relevant consumer advisory service. This Limited Warranty is in addition to your legal rights in relation to the Products and does not affect your statutory rights. This Limited Warranty only applies to Products purchased and used in the European Union.

1. WHAT THIS LIMITED WARRANTY COVERS; PERIOD OF COVERAGE

Nest Labs (Europe) Ltd. ("Nest Labs") warrants to the owner of the enclosed product that the product contained in this box ("Product") will be free from defects in materials and workmanship for a period of two (2) years from the date of delivery following the original retail purchase (the "Warranty Period"). If the Product fails to conform to this Limited Warranty during the Warranty Period, Nest Labs will, at its sole discretion, either (a) repair or replace any defective Product or component; or (b) accept the return of the Product and refund the money actually paid by the original purchaser for the Product. Repair or replacement may be made with a new or refurbished product or components, at Nest Labs' sole discretion, to the extent that this is permitted by local laws in your jurisdiction. If the Product or a component incorporated within it is no longer available, Nest Labs may, at Nest Labs' sole discretion, replace the Product with a similar product of similar function. Any Product that has either been repaired or replaced under this Limited Warranty will be covered by the terms of this Limited Warranty for the longer of (a) ninety (90) days from the date of delivery of the repaired Product or Replacement Product, or (b) the remaining Warranty Period. This Limited Warranty is transferable from the original purchaser to subsequent owners, but the Warranty Period will not be extended in duration or expanded in coverage for any such transfer.

2. TOTAL SATISFACTION RETURNS POLICY

If you are the original purchaser of the Product and you are not satisfied with this Product for any reason, you may return it, at

your cost, in its original condition, within thirty (30) days of the original purchase and receive a full refund.

3. WARRANTY CONDITIONS; HOW TO GET SERVICE IF YOU WANT TO CLAIM UNDER THIS LIMITED WARRANTY

Before making a claim under this Limited Warranty, the owner of the Product must (a) notify Nest Labs of the intention to claim by visiting [nest.com/eu/support](https://www.nest.com/eu/support) during the Warranty Period and providing a description of the alleged failure, and (b) comply with Nest Labs' returns/delivery instructions. Nest Labs will have no warranty obligations with respect to a returned Product if it determines, at its reasonable discretion after examination of the returned Product, that the Product is an Ineligible Product (defined below). Nest Labs will bear all costs of return/delivery to the owner and will reimburse standard delivery costs incurred by the owner, except with respect to any Ineligible Product, for which the owner will bear all delivery costs.

4. WHAT THIS LIMITED WARRANTY DOES NOT COVER

This Limited Warranty does not cover the following (collectively "Ineligible Products"): Products marked as "sample" or "Not for Sale", or sold "AS IS"; or Products that have been subject to: (a) modifications, alterations, tampering, or improper maintenance or repairs; (b) handling, storage, installation, testing or use not in accordance with the user's guide or other instructions provided by Nest Labs; (c) abuse or misuse of the Product; (d) breakdowns, fluctuations or interruptions in the electricity supply or the telecommunications network; or (e) Acts of God, including, but not limited to lightning, flood, tornado, earthquake or hurricane. This Limited Warranty does not cover consumable parts, including batteries, unless damage is due to defects in materials or workmanship of the Product or software (even if such consumable parts or software are packaged or sold with the product). Nest Labs recommends using only authorised service providers for maintenance or repair. Unauthorised use of the Product or software can impair the Product's performance and may invalidate this Limited Warranty.

5. DISCLAIMER OF WARRANTIES

EXCEPT AS STATED ABOVE IN THIS LIMITED WARRANTY, AND TO THE MAXIMUM EXTENT PERMITTED BY APPLICABLE LAW, NEST LABS DISCLAIMS ALL EXPRESS, IMPLIED AND STATUTORY WARRANTIES AND CONDITIONS WITH RESPECT TO THE PRODUCT, INCLUDING THE IMPLIED WARRANTIES OF MERCHANTABILITY AND FITNESS FOR A PARTICULAR PURPOSE. TO THE MAXIMUM EXTENT PERMITTED BY APPLICABLE LAW, NEST LABS ALSO LIMITS THE DURATION OF ANY APPLICABLE IMPLIED WARRANTIES OR CONDITIONS TO THE DURATION OF THIS LIMITED WARRANTY.

6. LIMITATION OF DAMAGES

IN ADDITION TO THE WARRANTY DISCLAIMERS ABOVE, IN NO EVENT WILL NEST LABS BE LIABLE FOR ANY INDIRECT,

CONSEQUENTIAL, INCIDENTAL, EXEMPLARY OR SPECIAL DAMAGES, INCLUDING ANY DAMAGES FOR LOST DATA OR LOST PROFITS, ARISING FROM, OR RELATING TO THIS LIMITED WARRANTY OR THE PRODUCT, AND NEST LABS' TOTAL CUMULATIVE LIABILITY ARISING FROM, OR RELATED TO THIS LIMITED WARRANTY OR THE PRODUCT WILL NOT EXCEED THE AMOUNT ACTUALLY PAID FOR THE PRODUCT BY THE ORIGINAL PURCHASER.

7. LIMITATION OF LIABILITY

IF YOU CHOOSE TO USE THEM, ONLINE SERVICES OFFERED BY NEST LABS, INC., A US AFFILIATE OF NEST LABS, ("SERVICES") PROVIDE YOU WITH INFORMATION ("PRODUCT INFORMATION") REGARDING YOUR NEST PRODUCTS OR OTHER PERIPHERALS CONNECTED TO YOUR PRODUCTS ("PRODUCT PERIPHERALS"). THE TYPE OF PRODUCT PERIPHERALS THAT MAY BE CONNECTED TO YOUR PRODUCT MAY CHANGE FROM TIME TO TIME. WITHOUT LIMITING THE GENERALITY OF THE DISCLAIMERS ABOVE, ALL PRODUCT INFORMATION IS PROVIDED FOR YOUR CONVENIENCE, "AS IS" AND "AS AVAILABLE". NEST LABS OR ITS AFFILIATE DOES NOT REPRESENT, WARRANT OR GUARANTEE THAT PRODUCT INFORMATION WILL BE AVAILABLE, ACCURATE OR RELIABLE, OR THAT PRODUCT INFORMATION OR USE OF THE SERVICES OR PRODUCT WILL PROVIDE SAFETY IN YOUR HOME. YOU USE ALL PRODUCT INFORMATION, THE SERVICES AND THE PRODUCT AT YOUR OWN DISCRETION AND RISK. YOU WILL BE SOLELY RESPONSIBLE FOR (AND NEST LABS AND ITS AFFILIATE DISCLAIM) ANY AND ALL LOSS, LIABILITY OR DAMAGES, INCLUDING TO YOUR WIRING, FIXTURES, ELECTRICITY, HOME, PRODUCT, PRODUCT PERIPHERALS, COMPUTER, MOBILE DEVICE, AND ALL OTHER ITEMS AND PETS IN YOUR HOME, RESULTING FROM YOUR USE OF THE PRODUCT INFORMATION, SERVICES OR PRODUCT. PRODUCT INFORMATION PROVIDED BY THE SERVICES IS NOT INTENDED AS A SUBSTITUTE FOR DIRECT MEANS OF OBTAINING THE INFORMATION.

8. VARIATIONS THAT MIGHT APPLY TO THIS LIMITED WARRANTY

Some jurisdictions do not allow limitations on how long an implied warranty lasts or specific exclusions, so some of the limitations set out above may not apply to you. If any court or relevant authority decides that any of these limitations is unenforceable, it should be deemed modified to the minimum extent necessary to make it enforceable. If this modification is not possible, the relevant provision should be deemed deleted. Any modification or deletion will not affect the validity of the rest of this Limited Warranty.

9. CONTACT INFORMATION

Please direct any questions about this Limited Warranty to Nest Labs (Europe) Ltd. at the address located at: [nest.com/eu/contact](https://www.nest.com/eu/contact)