



Cam-action
door closers

DORMA

TS 92
TS 91

in Contur Design



reddot design award
winner 2005

The universal closers for standard doors – tested and approved to EN 1154

As units designed especially for interior applications, the DORMA TS 92 and TS 91 door closers constitute the perfect complement to the DORMA TS 93 cam-action door closer system. They likewise come in the Contur design and, thanks to their linear drive mechanism with heart-shaped cam, they offer the same ease of use.

Moreover, their competitive pricing combined with their outstanding level of assured quality make them particularly attractive from an economic standpoint as well.

Certified to ISO 9001

Benefits

for the trade

- Inexpensive cam-action technology for standard interior doors.
- Low storage costs and reduced inventory requirement thanks to uniform slide channels of the Contur series.

for the fabricator

- Non-handed.
- Easy to fix and quickly adjustable.

for the architect/specifier

- Excellent value for money.
- Uniform appearance throughout the entire Contur slide channel range.

for the user

- Exceptional ease of use and fully controlled closing action.
- Optimum adaptability of the closing speed with reliable latching thanks to two regulating valves.

Data and features		TS 92 B/G ¹⁾	TS 91 B
Closing force	EN size	2–4	3
Adjustable		●	–
Standard doors ²⁾	up to 950 mm	–	●
	up to 1100 mm	●	–
External doors, outward opening ²⁾		–	–
Fire and smoke check doors		●	●
Non-handed design		●	●
Arm assembly	Slide channel	●	●
Closing speed and latching action independently adjustable	180°–15°		
	15°– 0°	●	●
at two separate valves			
Cushioned limit stay, mechanical		○	○
Backcheck		–	–
Delayed action		–	–
Hold-open		○	○
Weight in kg		2,0	1,9
Dimensions in mm	Length	281	267
	Overall depth	47	47
	Height	65	65
Door closer approved to EN 1154		●	●
CE mark for building products		●	●

● yes – no ○ option

¹⁾ B = Standard model for pull-side door leaf fixing/push-side transom fixing.

G = Special model for push-side door leaf fixing/pull-side transom fixing.

²⁾ For particularly heavy doors and doors which have to close against wind resistance, we recommend the DORMA TS 93.



The TS 92/TS 91 complies with the requirements and/or recommendations of the following:
CERTIFIRE approved for fire doors ITT 120, MM/IMM 240;
Ref. CF 119

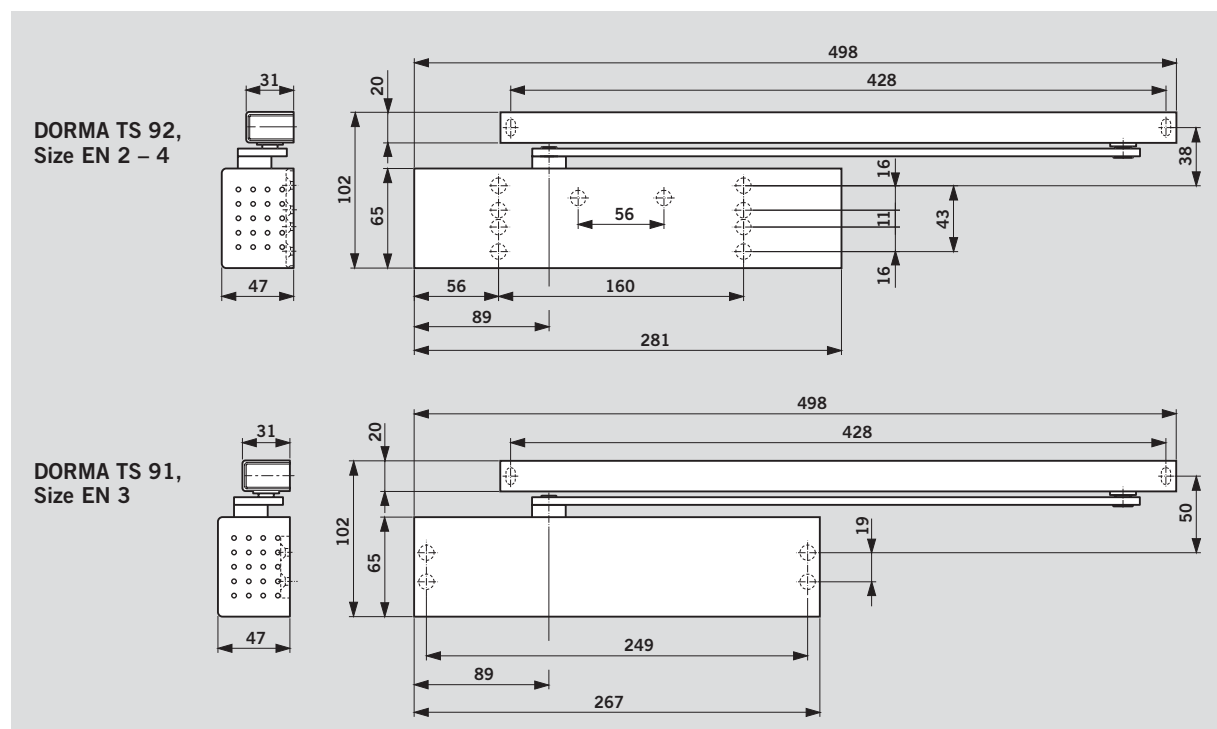

DORMA TS 92 B/G

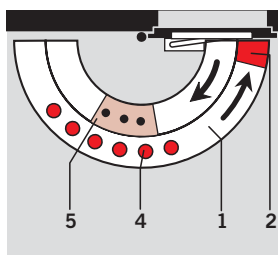
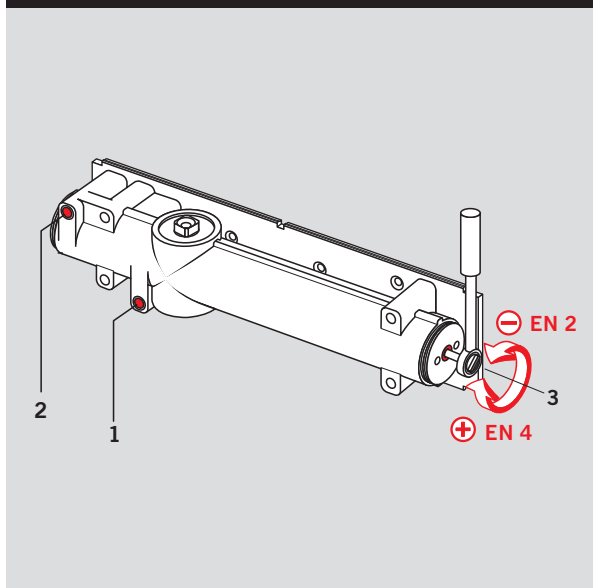

- 1 Variable closing speed in the range 180°–15°
- 2 Variable latching speed in the range 15°–0°
- 3 Infinitely variable closing force
- 4 Hold-open (option)
- 5 Cushioned limit stay (option)

The **closing speed** of the DORMA TS 92 is individually adjustable over two independent ranges at two separate valves.

The **closing force setting (spring strength)** for the relevant door width is adjusted with the infinitely variable lateral adjustment screw.

DORMA TS 91 B

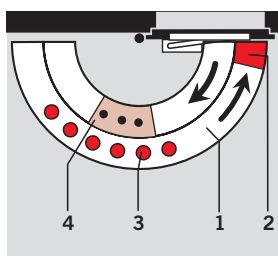
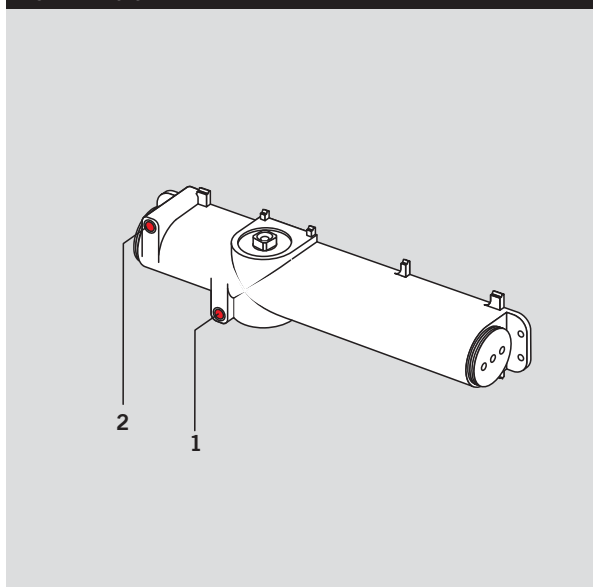

- 1 Infinitely variable closing speed in the range 180°–15°
- 2 Infinitely variable latching speed in the range 15°–0°
- 3 Hold-open (option)
- 4 Cushioned limit stay (option)

The **closing speed** of the DORMA TS 91 is individually adjustable over two independent ranges at two separate valves.

The **closing force (spring strength)** in the DORMA TS 91 is permanently set to size EN 3.

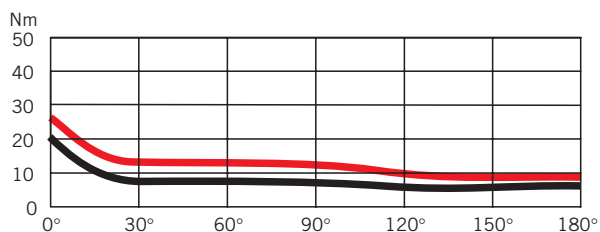

Force profile
Example: DORMA TS 92 B
Closing force setting:
size EN 3

— Opening resistance
— Closing force

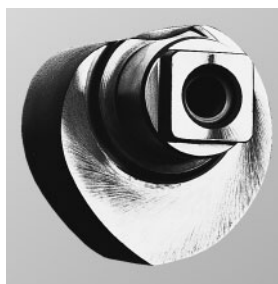

The heart-shaped cam and the linear drive mechanism which characterise all DORMA cam-

action door closers produce a rapidly decreasing opening torque, so greatly reducing the amount of effort required. This means that even children, the elderly and the disabled can open doors with ease. The user-friendliness of the system is further enhanced by the reliable latching action achieved by the fact that the closing force only rises in the end phase of the cycle.

Door leaf fixing, pull side (example shows LH [ISO 6] door; RH [ISO 5] doors mirrored arrangement)

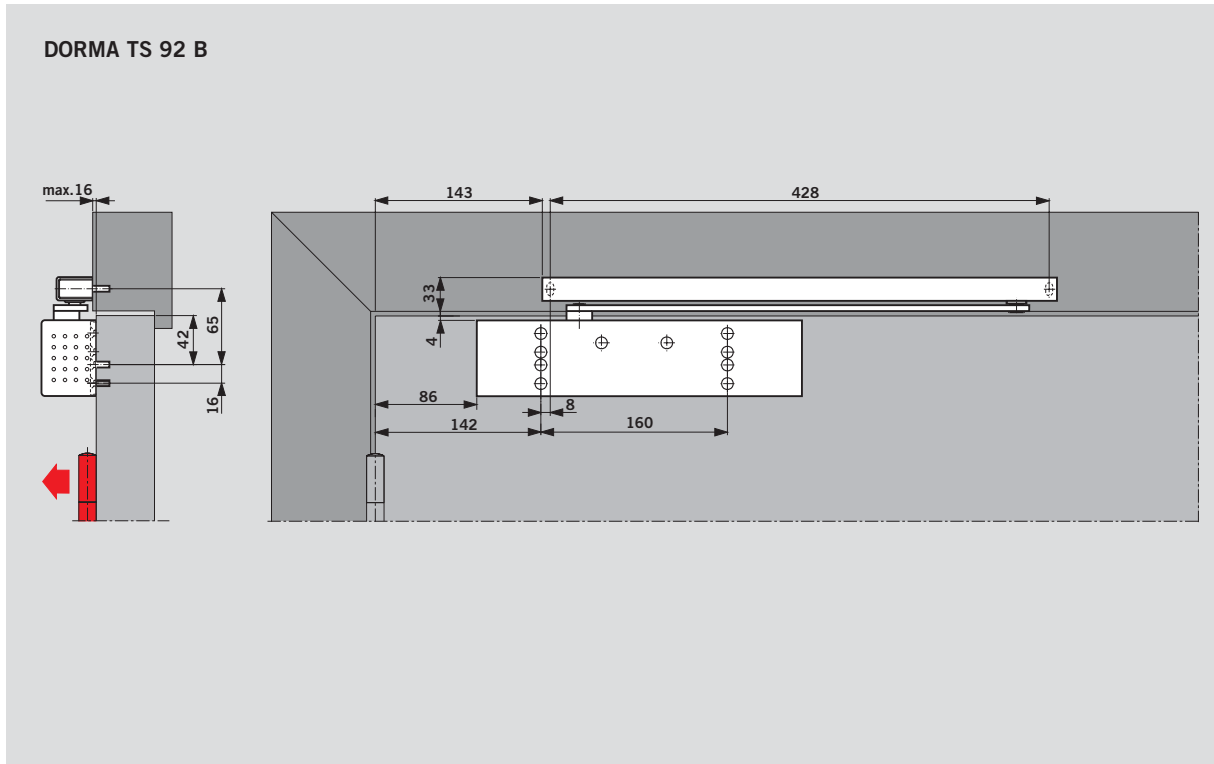

Provided the structural conditions allow, an opening angle of 180° is possible with this method of fixing. In most cases, however, a wall recess will have to be provided for the door closer.

Transom fixing, push side (example shows LH [ISO 6] door; RH [ISO 5] doors mirrored arrangement)

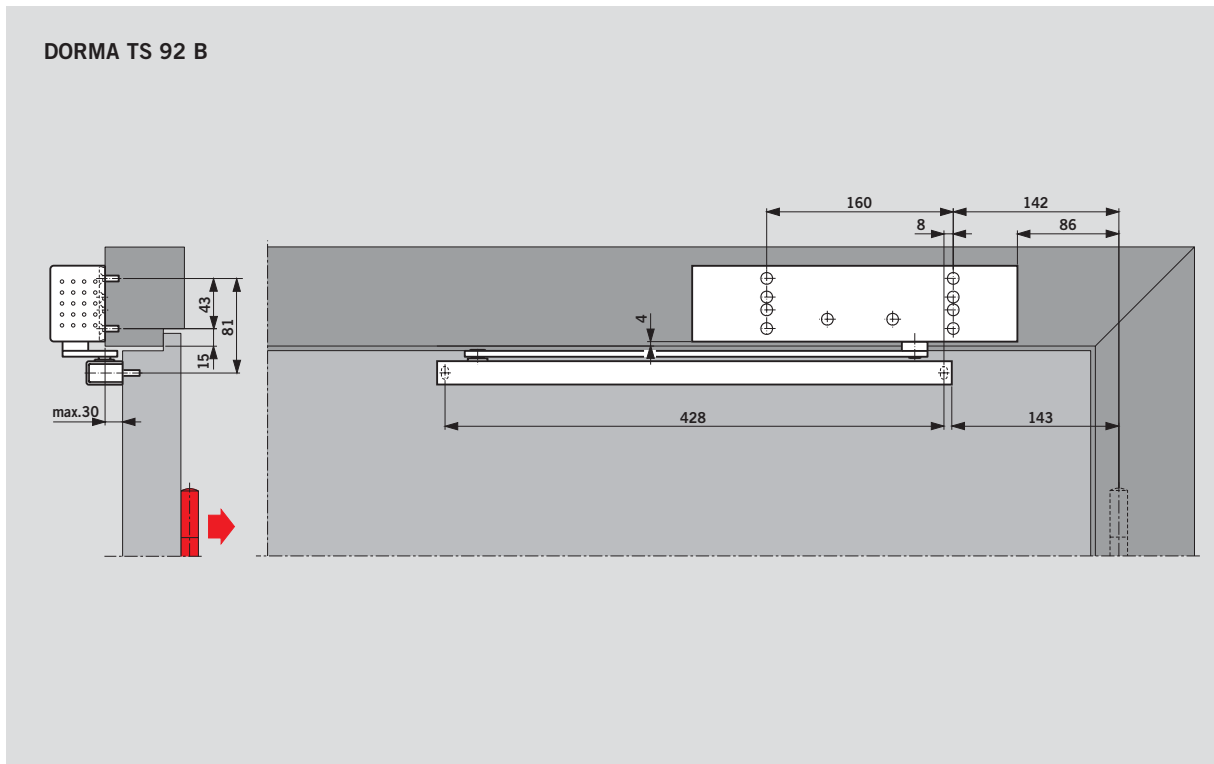

Depending on the structural conditions, the door opening angle with this method of fixing is limited to approx. 120° to 145°. In order to avoid damage to the door or door closer, users are recommended to install a cushioned backstay or a door stop.

Door leaf fixing, push side (example shows LH [ISO 6] door; RH [ISO 5] doors mirrored arrangement)

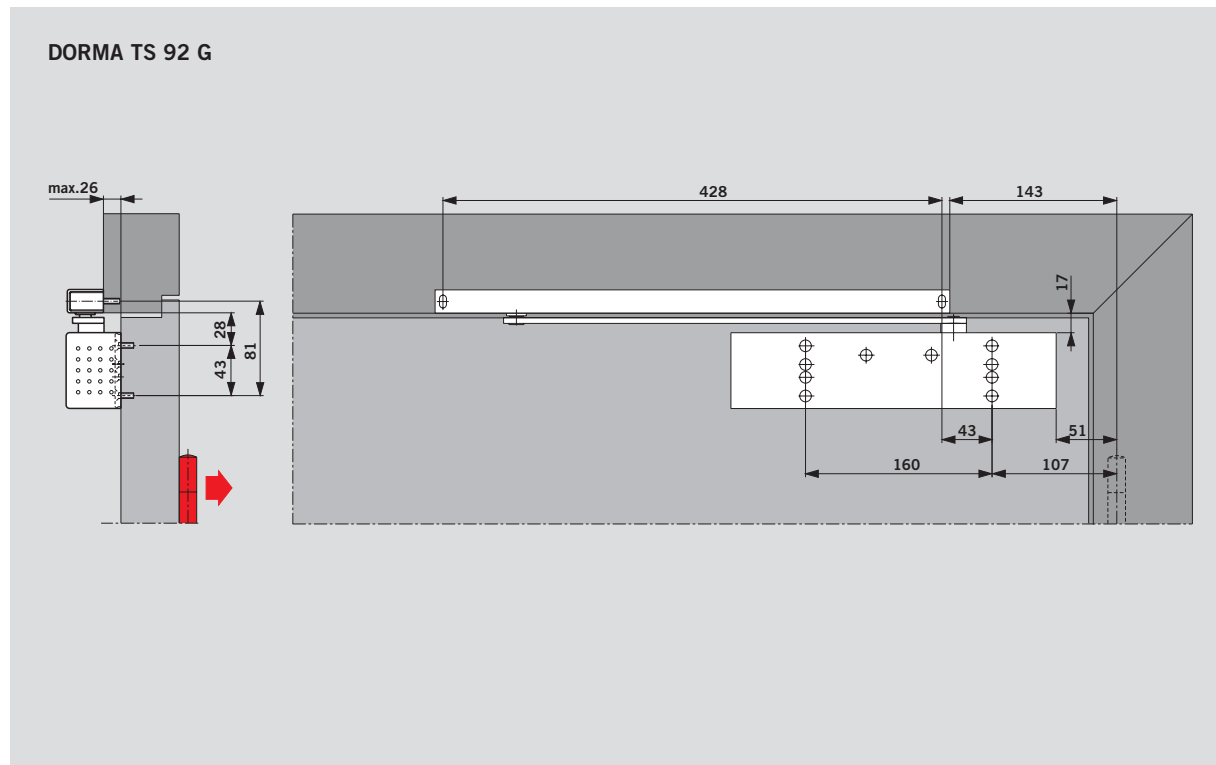

Depending on the structural conditions, the door opening angle with this method of fixing is limited to approx. 120° to 145°. In order to avoid damage to the door or door closer, users are recommended to install a cushioned backstay or a door stop.

Transom fixing, pull side (example shows LH [ISO 6] door; RH [ISO 5] doors mirrored arrangement)

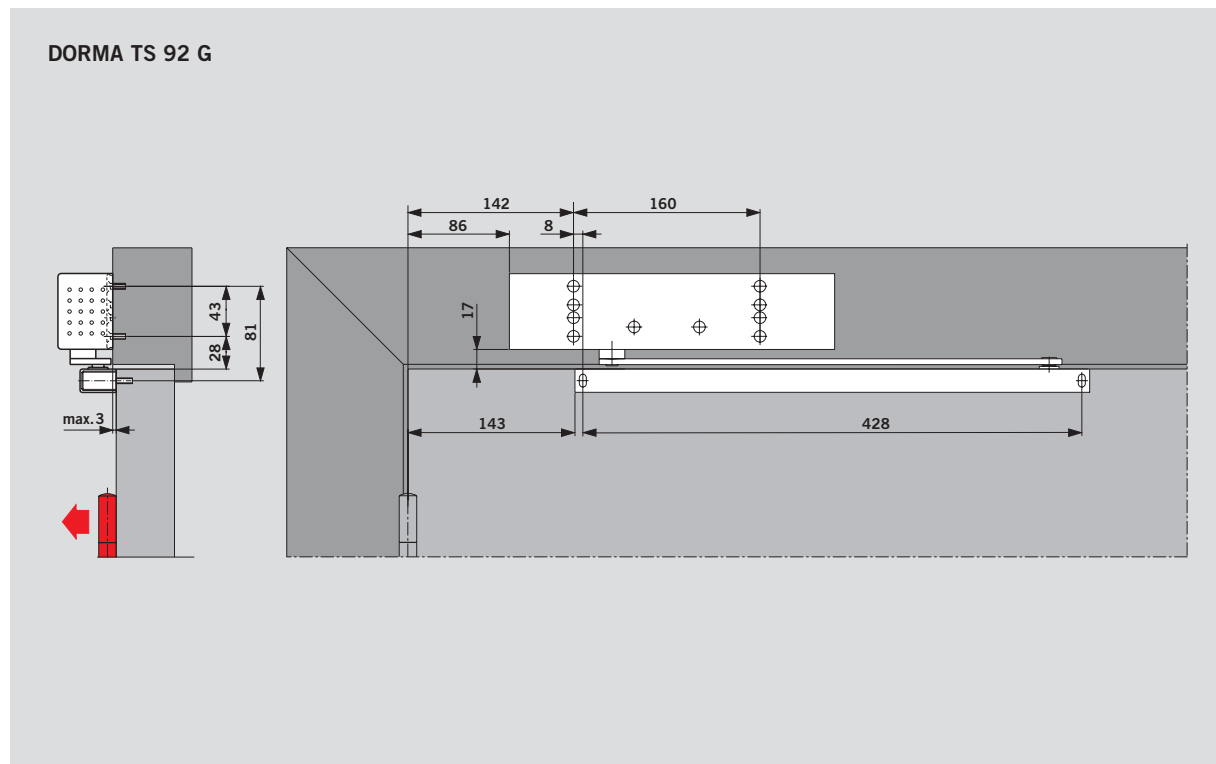

Provided the structural conditions allow, an opening angle of 180° is possible with this method of fixing.

Door leaf fixing, pull side (example shows LH [ISO 6] door; RH [ISO 5] doors mirrored arrangement)

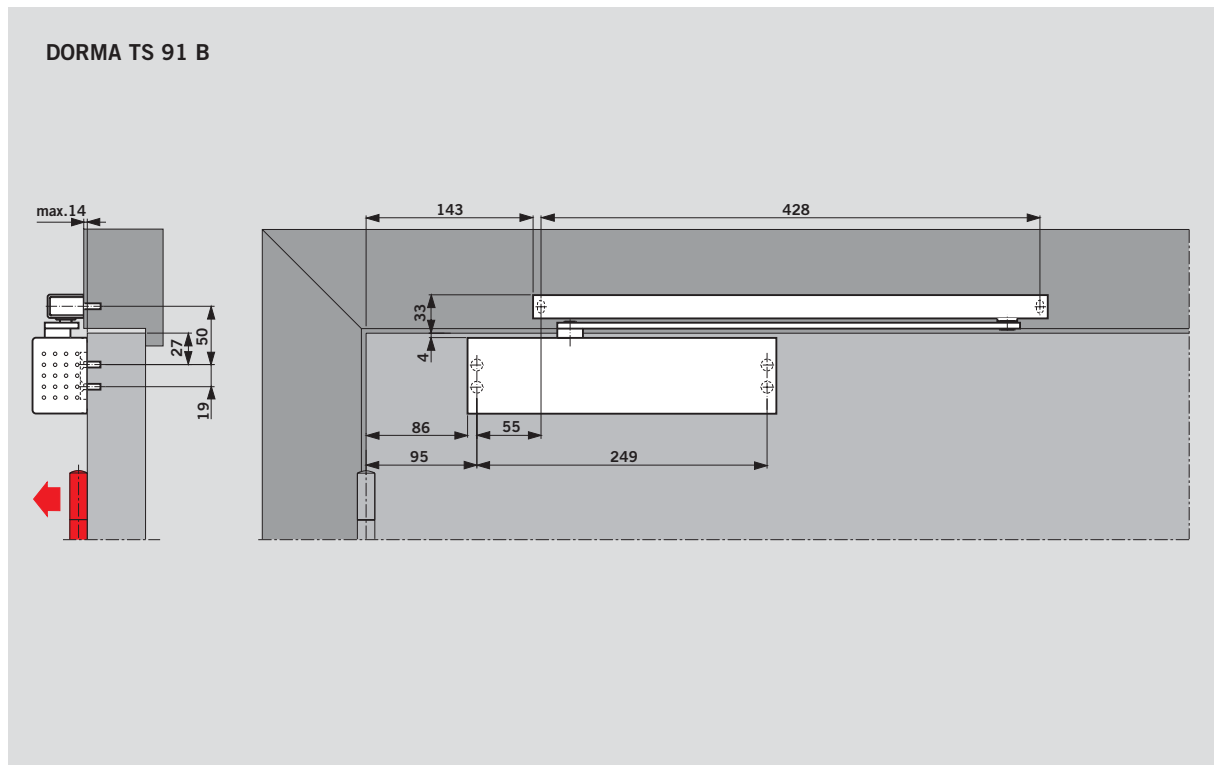

Provided the structural conditions allow, an opening angle of 180° is possible with this method of fixing. In most cases, however, a wall recess will have to be provided for the door closer.

Transom fixing, push side (example shows LH [ISO 6] door; RH [ISO 5] doors mirrored arrangement)

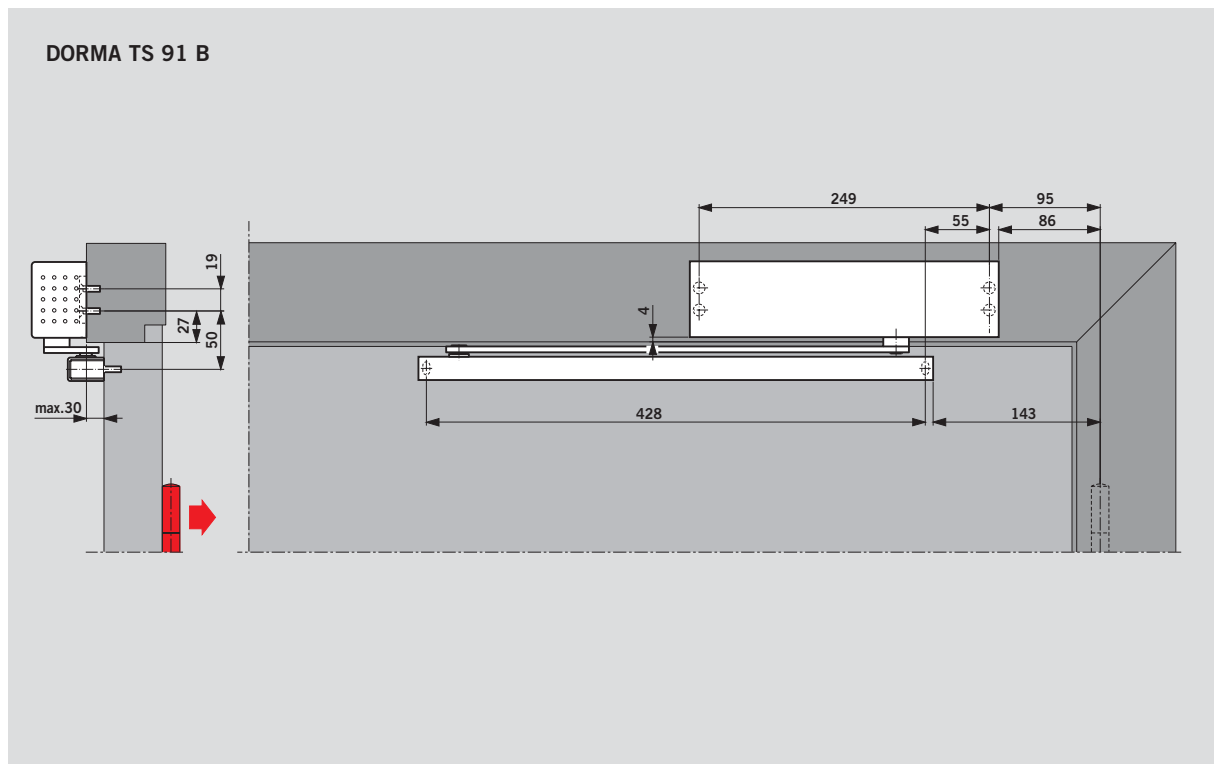

Depending on the structural conditions, the door opening angle with this method of fixing is limited to approx. 120° to 145°. In order to avoid damage to the door or door closer, users are recommended to install a cushioned backstay or a door stop.

Slide channel

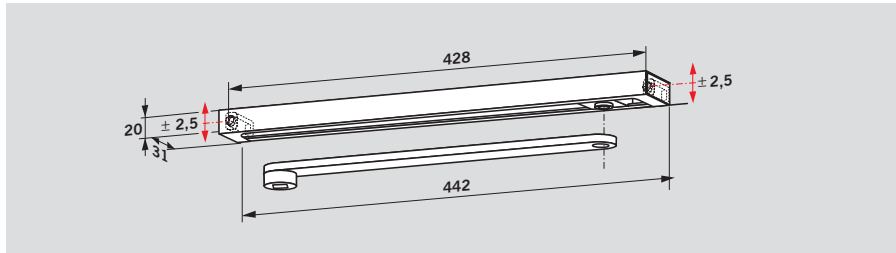

The **DORMA G-N** slide channel assembly comprises the main arm, slide channel, slide block, fixings, screws and end caps. The DORMA G-N slide channel

is non-handed and can be combined with both door closers. Thanks to oblong holes in the fixing pads, it is possible to compensate for deviations in the drill hole

pattern and to keep the door closer body and slide channel perfectly parallel.

Hold-open unit

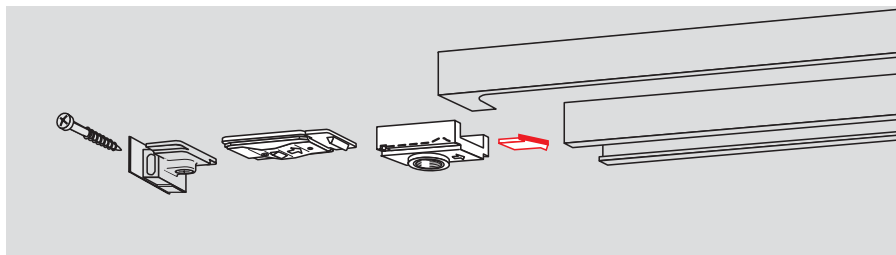

The DORMA RF mechanical hold-open unit ensures that doors are held open at precisely the correct angle – up to approx. 150° – without any fallback.

The hold-open unit can be switched on and off by the user as required, and the pull-off force can be adjusted to suit each individual door situation.

The DORMA RF hold-open unit is non-handed and can also be supplied for retrofitting to the slide channel at a later date.

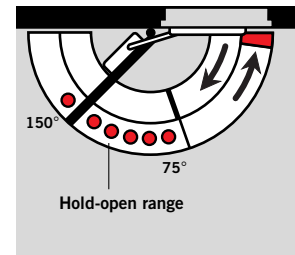

Cushioned limit stay

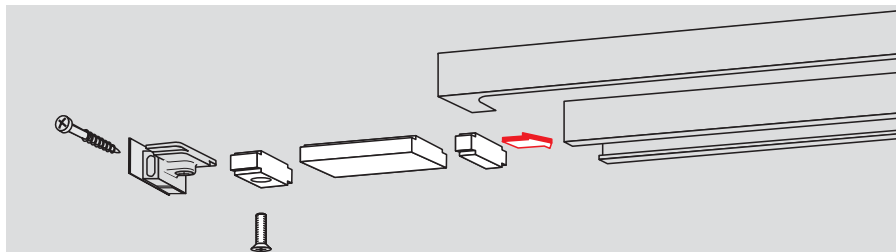

Cushioned limit stay simply slides into the slide channel. Adjustable between 80° and max. 120°. Also suitable for retrofitting.

Fitting a cushioned limit stay prevents doors which are opened normally from impacting against adjacent walls.

The cushioned limit stay is not an overload protection device and in many applications will not be a suitable substitute for a door stop.

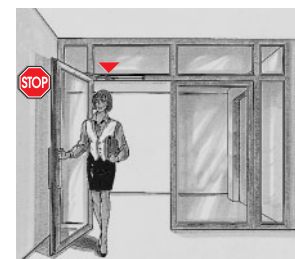
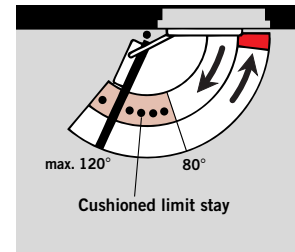

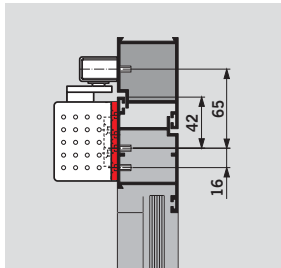

Mounting backplate for DORMA TS 91

For fixing to doors which provide no means of direct mounting.
Fixing hole pattern as per Supplement 1 to EN 1154.

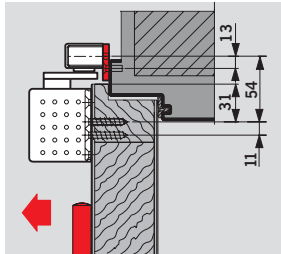
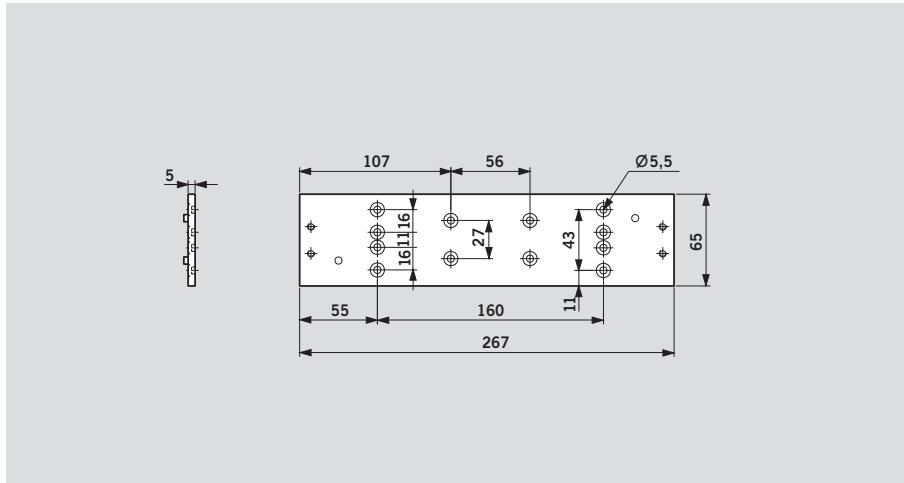

Mounting backplate 30 mm for G-N

For fixing the slide channel to the door frame where there is no means of direct mounting.

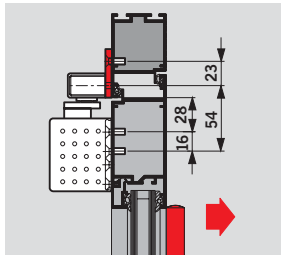
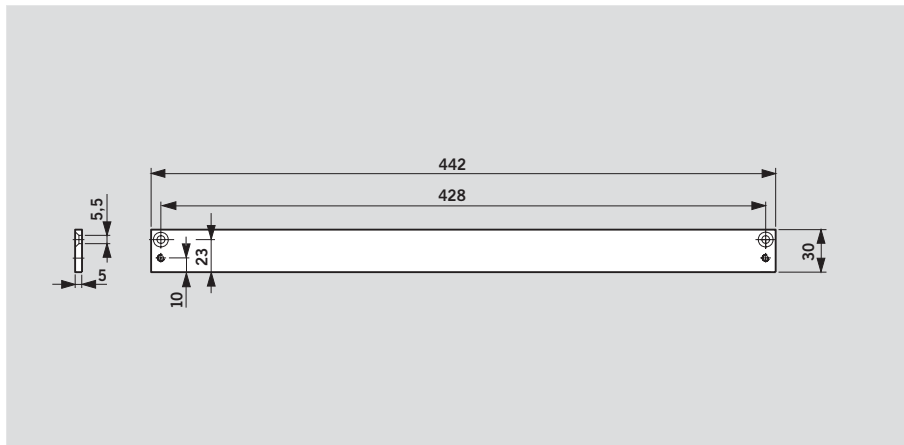

Mounting backplate 40 mm for G-N

For fixing the slide channel to the door frame where there is no means of direct mounting.

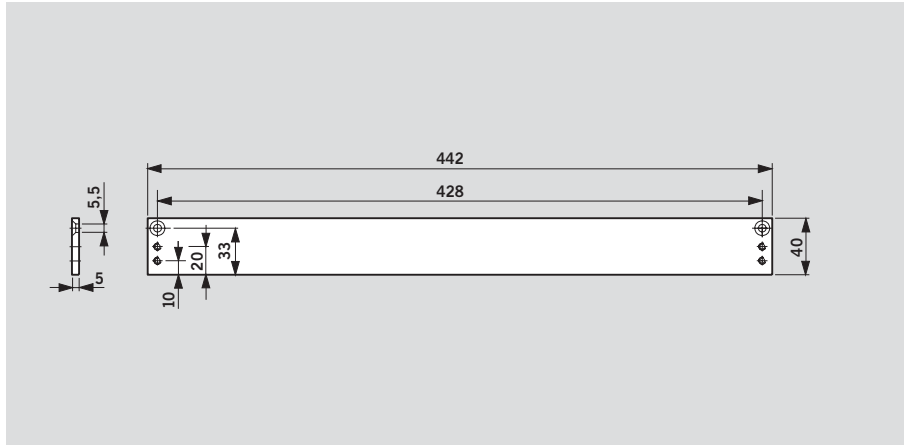

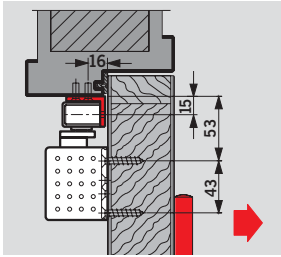



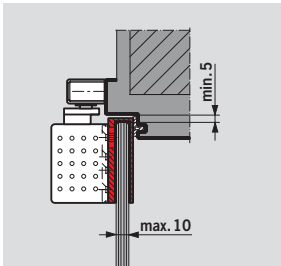
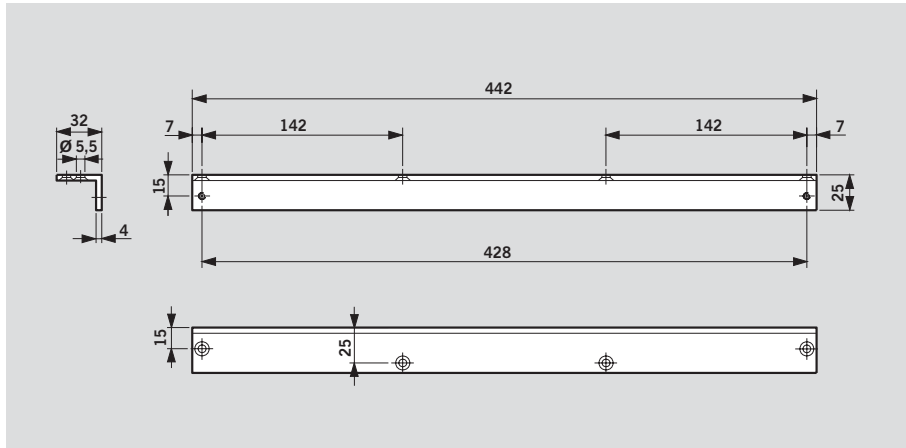



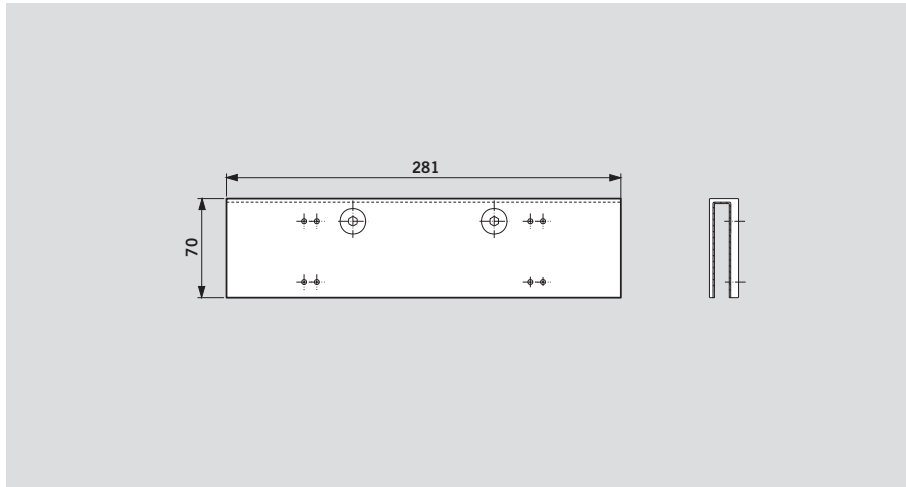



Angle bracket for G-N
For push-side fixing of the slide channel to door frames with a deep reveal.



Glass door saddle plate for DORMA TS 92
For fixing the closer to toughened glass doors – No glass drilling or recessing required.



Standard equipment and accessories							
	Cam-action door closer TS 92 B	Cam-action door closer TS 92 G	Cam-action door closer TS 91 B	Mounting backplate for G-N	Angle-bracket for G-N	Cushioned limit stay for G-N	Hold-open unit for G-N
	 Size EN 2-4 ■ 420201xx □	 Size EN 2-4 ■ 420301xx □	 Size EN 3 ■ 410201xx □	 30 mm 644000xx 40 mm 644100xx	 644300xx	 35800093	 18570000
Slide channel G-N  □ 640100xx	■ □	■ □	■ □	#	#	#	#
Mounting backplate for TS 91  410002xx			#				
Glass door saddle plate for TS 92  420001xx	#	#					

Order number:

■ = Closer body separate

□ = Arm assembly separate

= Accessory

Colour

Silver

Special colour

White (RAL 9016)

xx The TS 92 is also available in our "Design" surface finishes.

01

09

11

Stainless steel "Design" 04

Polished brass 05

Specification text TS 92 B/G

Cam-action door closer, CERTIFIRE approved (CF 119), in Contur design with linear drive and rapidly decreasing opening resistance/torque, adjustable closing speed in two independent ranges and mounting backplate with universal fixing hole pattern; closing force infinitely variable between size EN 2 and EN 4. Non-handed. Approved to EN 1154.

Accessories

- Hold-open unit
- Cushioned limit stay
- Mounting backplate for G-N
- Angle bracket for G-N
- Saddle plate for toughened glass doors

Colour

- silver
- white (sim. to RAL 9016)
- stainless steel
- polished brass
- special colour (sim. to RAL)

Make

- DORMA TS 92 B
- DORMA TS 92 G

Model

- TS 92 B
- TS 92 G

Specification text TS 91 B

Cam-action door closer, CERTIFIRE approved (CF 119), in Contur design with linear drive and rapidly decreasing opening resistance/torque, adjustable closing speed in two independent ranges and mounting backplate with universal fixing hole pattern; closing force EN 3. Non-handed. Approved to EN 1154.

Accessories

- Hold-open unit
- Cushioned limit stay
- Mounting backplate for G-N
- Mounting backplate

Colour

- silver
- white (sim. to RAL 9016)
- special colour (sim. to RAL)

Make

- DORMA TS 91 B

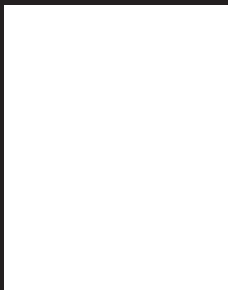

www.dorma.com

Door Control Division worldwide

Central Europe

DORMA GmbH + Co. KG
Breckerfelder Str. 42-48
D-58256 Ennepetal
Tel. +49 23 33/7 93-0
Fax +49 23 33/7 93-4 95

Australia

DORMA Door Controls Pty. Ltd.
52 Abbott Road
Hallam/Victoria 3803
Australia
Tel. +61 3/97 96 35 55
Fax +61 3/97 96 39 55

China

DORMA Door Controls (Suzhou)
Co. Ltd.
No. 9, Hong Feng Road
Suzhou Singapore Industrial Park
Suzhou, 215021
P. R. of China
Tel. +86 512/67612481
Fax +86 512/67614582

DORMA Door Controls Pte. Ltd.
Room 701, Technology Plaza
651 King's Road
North Point
Hong Kong
Tel. +825/250 34632
Fax +825/288 75370

Emerging Markets

DORMA GmbH + Co. KG
Breckerfelder Str. 42-48
D-58256 Ennepetal
Tel. +49 23 33/7 93-0
Fax +49 23 33/7 93-4 95

DORMA Door Controls (Pty.) Ltd.
Kings Court, 4A Mineral Crescent
ZA-2000 Crown/Gauteng
South Africa
Tel. +27 11/8 30 02 80
Fax +27 11/8 30 02 91

Far East

DORMA Far East Pte. Ltd.
No. 31 Gul Lane,
Singapore 629425
Tel. +65 62 68/76 33
Fax +65 62 65/79 14

France

DORMA France S.A.S.
Europarc
42, rue Eugène Dupuis
F-94046 Créteil
Tel. +33 1/41 94 24 00
Fax +33 1/41 94 24 01

Gulf

DORMA Gulf Door Controls FZE
Jebel Ali Free Zone,
Roundabout 8,
Unit VC 02
Dubai, United Arab Emirates
Tel. +971 48/83 90 14
Fax +971 48/83 90 15

North America

DORMA Architectural Hardware
DORMA Drive, Drawer AC
Reamstown, PA 17567
Tel. +1-800-523-8483
Fax +1-800-274-9724

Scanbalt

DORMA Danmark A/S
Sindalvej 6 - 8
DK-2610 Rødovre
Tel. +45 44/54 30 00
Fax +45 44/54 30 01

South America

DORMA Sistemas de Controles
para Portas Ltda.
Av. Piracema, 1400
Centro Empresarial Tambore
CEP 06400 Barueri/
São Paulo, Brasil
Tel. +55 11/41 91 32 44
Fax +55 11/41 91 21 93

South-East Europe

DORMA AUSTRIA GmbH
Pebering Strass 22
A-5301 Eugendorf
Tel. +43 62 25/2 84 88
Fax +43 62 25/2 84 91

South Europe

DORMA Italiana S.r.l.
Via. A. Canova 44/46
I-20035 Lissone (MI)
Tel. +39 039/24 40 31
Fax +39 039/24 40 33 10
DORMA Ibérica, S.A.
Camino San Martin de la Vega, 4
E-28500 Arganda del Rey
(Madrid)
Tel. +34 91/8 75 78 50
Fax +34 91/8 75 78 81

UK/Ireland

DORMA UK Ltd.
Door Controls Division
Wilbury Way
GB-Hitchin
Hertfordshire SG4 0AB
Tel. +44 14 62/47 76 00
Fax +44 14 62/47 76 01



Door Control

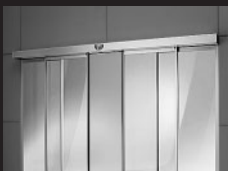

Automatic



Glass Fittings
and Accessories



Security/Time
and Access (STA)



Movable Walls



4 102 12 26 3 17 6 6 2 1