



Door Closer

DORMA TS 72

The ideal solution for doors up to 1100mm wide – tested and approved to EN 1154

The DORMA TS 72 is the ideal multi-purpose door closer for all standard door designs and constructions. Without a backplate, it is particularly easy and quick to fix. The spring strength can be individually adapted to the door size by means of an

allen key ensuring optimum performance in every situation.



Quality assured manufacture to DIN ISO 9001, EN 29001, BS5750. Certified and verified by BSI Quality Assurance Reg.-No. Q 6423, FM 10756



Benefits

- For the trade**
- Just one model for all standard doors.
 - Increased stocking flexibility thanks to use of the standard ClassicLine series arm.

- For the installer/fabricator**
- Non-handed design.
 - Closing force, closing speed and latching action adjustable in just a few movements.

- For the architect/specifier**
- Outstanding value for money.
 - Compact construction combined with timeless design.

- For the user**
- Constant closing action virtually unaffected by temperature fluctuations.
 - Optimum closing speed adjustment with two regulating valves.
 - Reliable closing with adjustable latching action.
 - Optimum wall and door protection thanks to "thinking" backcheck on TS 72 VBC.

F Approval Certification

The DORMA TS 72 V / TS 72 VBC is CERTIFIRE approved (Certificate No. CF 268) for door types ITT 120 MM/IMM 240



Data and features		TS 72 V	TS 72 VBC
Spring strength adjustable	Size	EN 2-4	EN 2-4
Standard doors	<1100mm ¹⁾	●	●
External doors, outward opening		–	–
Fire doors		●	●
Non-handed		●	●
Arm type	Standard	●	●
	Slide channel	–	–
Closing speed adjustable at 2 separate valves	180° - 15°	●	●
	15° - 0°	●	●
Latching action adjustable (by arm)		●	●
Backcheck		–	●
Delayed action		–	–
Hold-open		○	○
Weight in kg		1.2	1.2
Dimensions in mm	Length	232	232
	Overall depth	45	45
	Height	68	68
Door closer tested and approved to EN1154		●	●

● Yes – No ○ Option

1) With parallel-arm fixing, the closing force is approx. 20Nm (for doors up to 950mm)

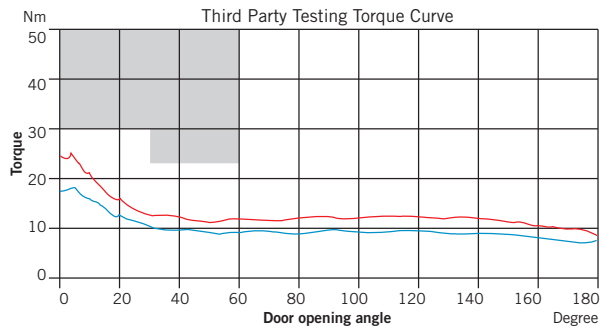

Controlled door closing device EN 1154

Manufacturer: DORMA
Model: TS 72 EN2-4 BC
Sample: B 1
Size: 3
5000 cycles

Standard installation
Heins
08.08.08

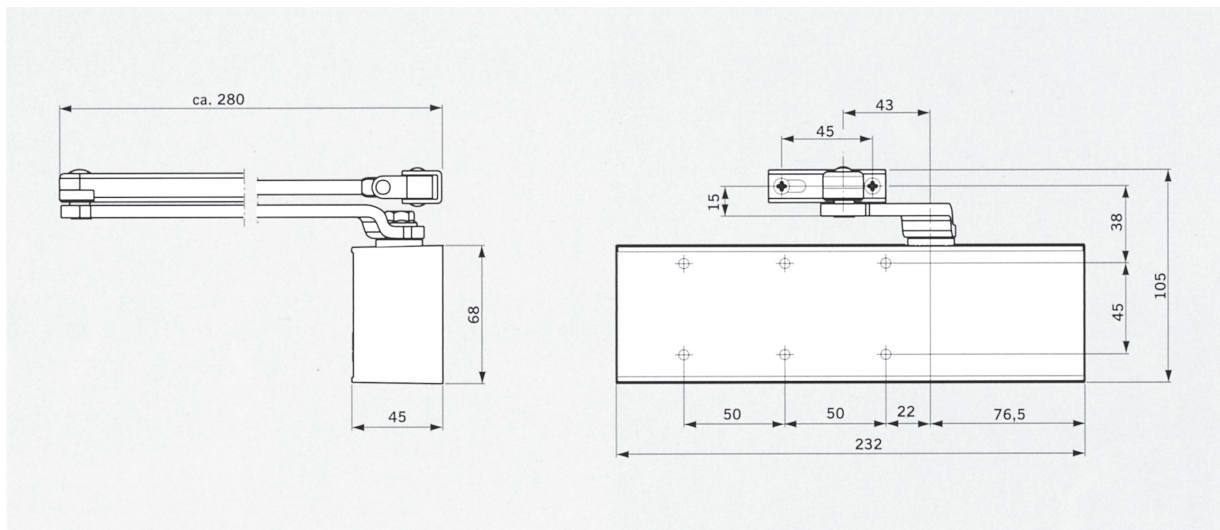

Door leaf fixing, pull side

(Example refers to left-hand [ISO 6] door; mirror image applies to right-hand [ISO 5] door)

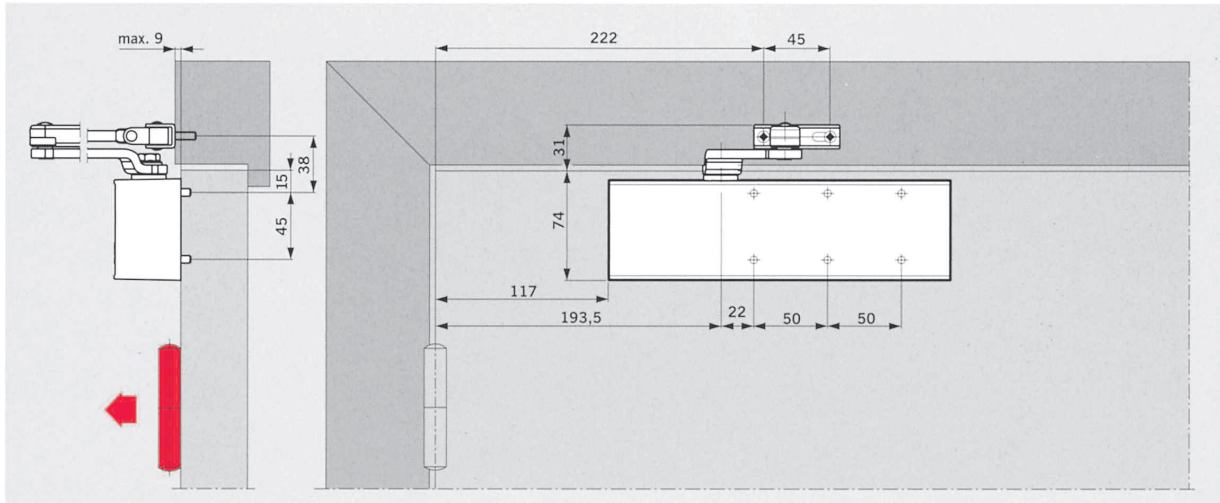

Transom fixing (overhead frame installation), push side

(Example refers to left-hand [ISO 6] door; mirror image applies to right-hand [ISO 5] door)

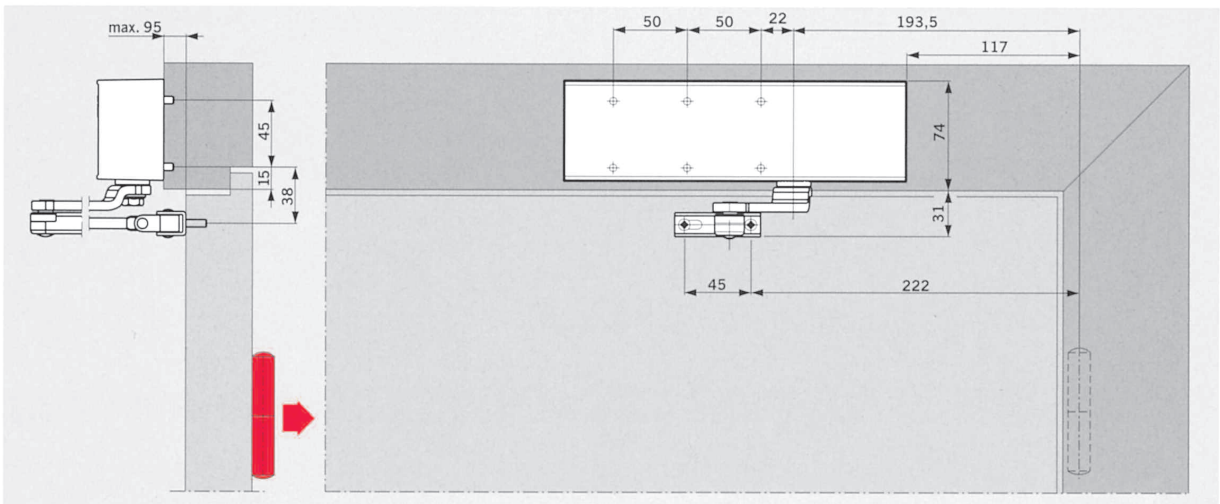

Parallel-arm fixing, push side

(Example refers to left-hand [ISO 6] door; mirror image applies to right-hand [ISO 5] door) Parallel-arm bracket (accessory) necessary

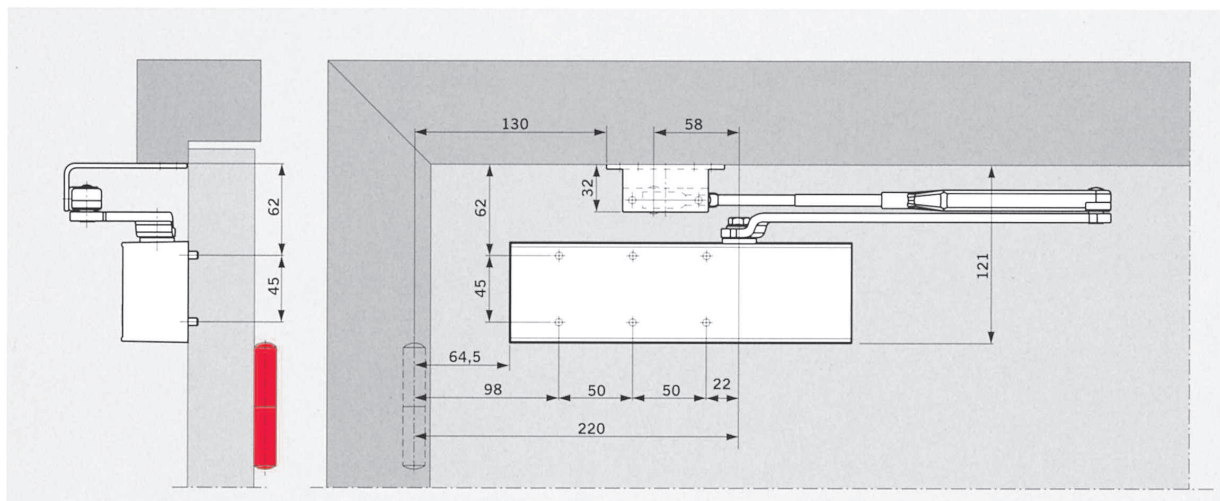

With this fixing method, the closing force is approx. 20 Nm (for doors up to 950mm)

Mounting backplate

For fixing to doors on which the closer cannot be directly installed. Drilled hole pattern as per EN 1154, Supplement 1.

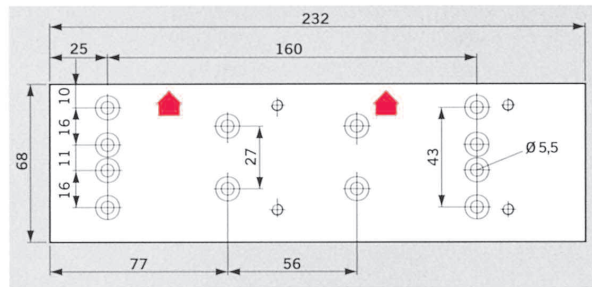
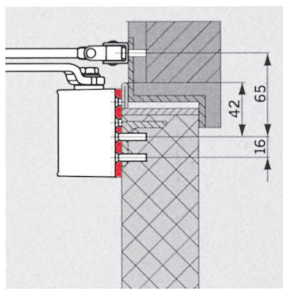

Upstand hinge bracket

For fixing the arm to particularly narrow door frames.

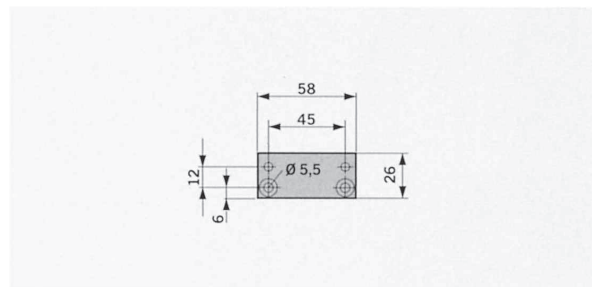
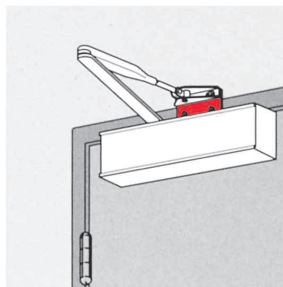

Fixing bracket

For the parallel-arm configuration.

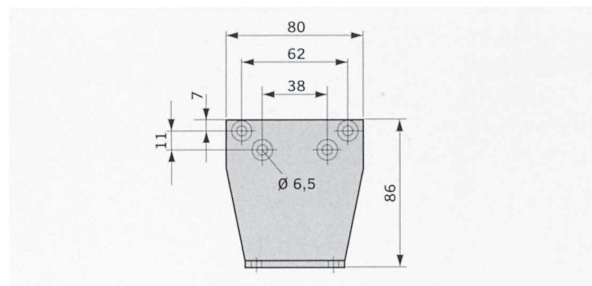
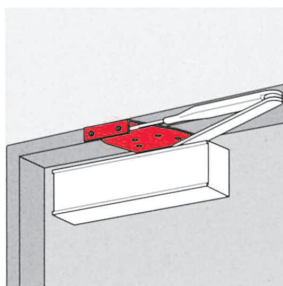

Standard and optional functions

The **closing speed** of the DORMA TS 72 is variable in two independent ranges by separate valves.

In addition, the **latching action** can be adjusted at the closer arm.

The **closing force (size setting)** for the door width concerned is variable at the adjustment screw located at the end face of the TS 72 closer body.

Door width	Setting
≤ 850	EN 2
≤ 950	EN 3
≤ 1100	EN 4

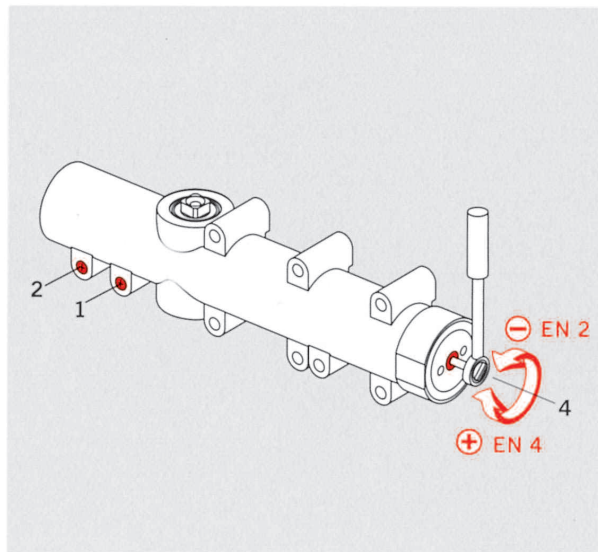

With “thinking” backcheck (TS 72 VBC only) –

Thanks to an innovative design concept, the resistance developed by this backcheck system is directly proportional to door acceleration as the door is opened beyond approx. 70°. It is almost imperceptible when the door is opened slowly. However, if the door is opened roughly, the backcheck responds in equal measure.

And if the door should be flung open at speed – whether deliberately, thoughtlessly, accidentally or as a result of a gust of wind – the backcheck reacts at full strength, protecting the wall and door from damage.

If backcheck function is required, the system can simply be switched on.

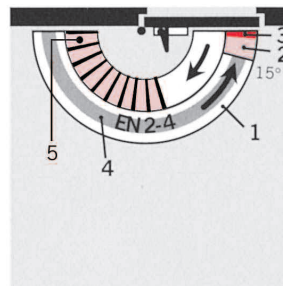

- 1 Closing speed adjustable in the range 180° – 15°.
- 2 Closing speed adjustable in the range 15° – 0°.
- 3 Latching action (variable at arm).
- 4 Adjustable closing force.
- 5 Self-adjusting backcheck (TS 72 VBC).



If the DORMA TS 72 is installed with a **hold-open arm**, the doors can be held open at any desired point (up to approx. 150°).



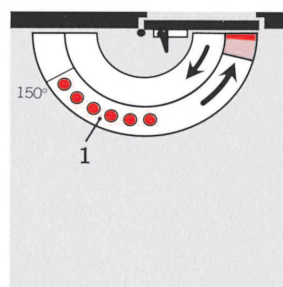

Hold-open arms are not approved for Fire Doors.



- 1 Hold-open range

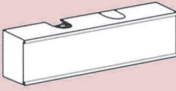
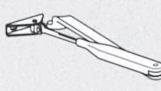

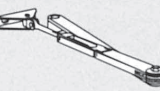
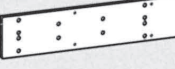
Standard equipment and accessories

Closer body TS 72 V TS 72 VBC 	Standard arm 	Architrave bracket 	Parallel-arm bracket 	Hold-open arm 	Mounting backplate 	Hinge plate 
--	---	---	---	---	---	--

Finishes

Silver
 Gold
 Colour Coated
 Polished Stainless Steel
 Satin Stainless Steel
 Polished Brass

Specification text
TS 72 V

Rack-and-pinion door closer with adjustable closing force, size EN 2 – 4, closing speed adjustable in two independent ranges, with adjustable latching action. Non-handed. Tested and approved to EN 1154. Certifire Approved CF268.

TS 72 VBC

Rack-and-pinion door closer with adjustable closing force, size EN 2 – 4, closing speed adjustable in two independent ranges, with adjustable latching action and “thinking” backcheck. Non-handed. Tested and approved to EN 1154. Certifire Approved CF268.

Model

With standard arm and fixing bracket for parallel-arm assembly

Accessories

Hold-open arm
 Mounting backplate
 Upstand hinge plate

Finishes

Silver
 Gold
 Colour Coated
 Polished Stainless Steel
 Satin Stainless Steel
 Polished Brass

DORMA UK Limited

Wilbury Way
 Hitchin
 Hertfordshire
 SG4 0AB
 Tel: 01462 477600
 Fax: 01462 477601
 E-mail:
 hardware@dorma-uk.co.uk

www.dorma-uk.co.uk

DORMA Ireland Limited

19 Sandyford Office Park
 Foxrock
 Dublin 18
 Tel: 01 295 8280
 Fax: 01 295 8284
 E-mail:
 dormadublin@dorma.ie

www.dorma.ie