



Battery Powered Smoke & Heat Alarms Ei600 Series



Ei605 Smoke Alarm Series



Ei603 Heat Alarm Series

Instructions

Read and retain carefully for as long as the product is being used. It contains vital information on the operation and installation of your Alarm. The leaflet should be regarded as part of the product.

If you are just installing the unit, the leaflet must be given to the householder. The leaflet is to be given to any subsequent user.

Table 1**9V Replaceable Battery**

Model	Alarm Type	Hardwired Interconnect	RF Capability Supplied	Optional RF Module Model No.
Ei605	Optical	No	No	None
Ei605C	Optical	Yes	Yes	Ei605MRF
Ei605W	Optical	No	Yes	Ei605MRF
Ei603C	Heat	Yes	Yes	Ei605MRF
Ei603W	Heat	No	Yes	Ei605MRF

10 Year Lithium Battery Built-in

Model	Alarm Type	Hardwired Interconnect	RF Capability Supplied	Optional RF Module Model No.
Ei605TY	Optical	No	No	None
Ei605TYC	Optical	Yes	Yes	Ei605MTYRF
Ei605TYW	Optical	No	Yes	Ei605MTYRF
Ei603TYC	Heat	Yes	Yes	Ei605MTYRF
Ei603TYW	Heat	No	Yes	Ei605MTYRF

Note: Certain alarms may be supplied (on request) with the appropriate RF module fitted

CONTENTS

Page

1	QUICK START GUIDE	4
2	LOCATION & POSITIONING	6
3	INSTALLATION	13
4	INTERCONNECTION - HARD WIRED	17
5	TESTING, MAINTENANCE & POWER SUPPLY MONITORING	20
6	FIRE SAFETY ADVICE	26
7	SMOKE ALARM LIMITATIONS	29
8	RADIOLINK ACCESSORIES	31
9	GETTING YOUR ALARM SERVICED	31
10	FIVE YEAR GUARANTEE	32
11	TROUBLESHOOTING	33
12	CONTACT US	36

1. Quick Start Guide

1

LOCATE CORRECT SITING POINT

FIX BASEPLATE TO CEILING

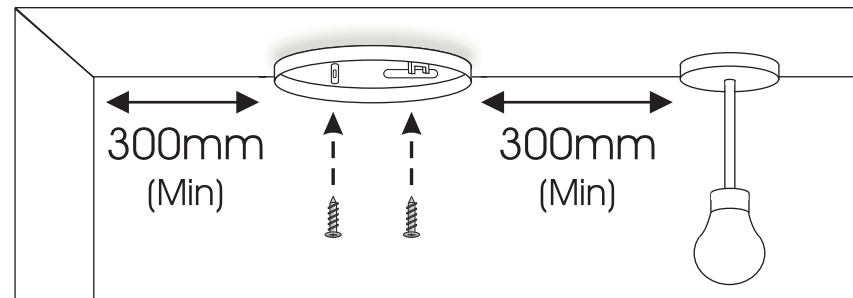

ALARM SHOULD BE CEILING MOUNTED AT LEAST 300MM FROM WALLS & OBSTRUCTIONS, IDEALLY CENTRALLY IN ROOM/AREA

2

CONNECT BATTERY SNAPS

9V BATTERY MODELS ONLY

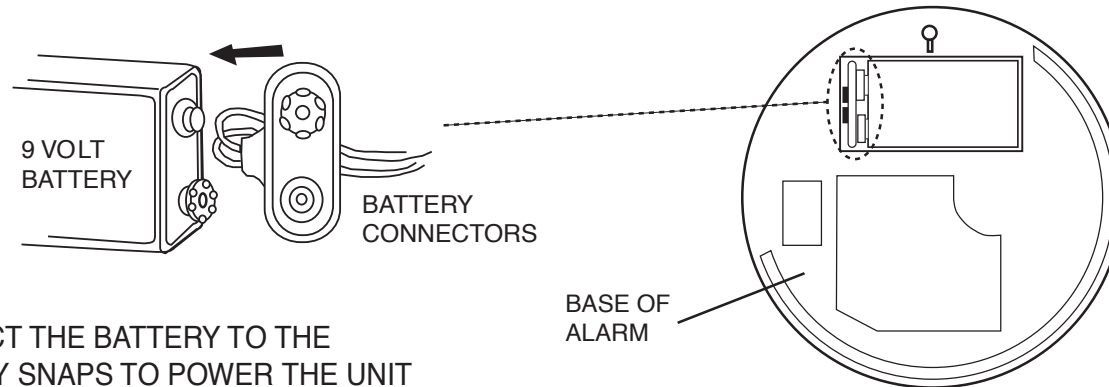

CONNECT THE BATTERY TO THE BATTERY SNAPS TO POWER THE UNIT

Quick Start Guide

3

PLACE ALARM & TWIST ON TO BASE

ON 10 YEAR LITHIUM BATTERY ALARM MODELS - TWISTING THE UNIT ON TO THE BASE AUTOMATICALLY CONNECTS THE BATTERY

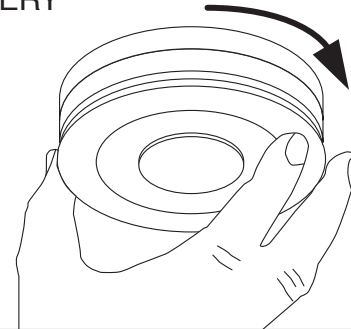
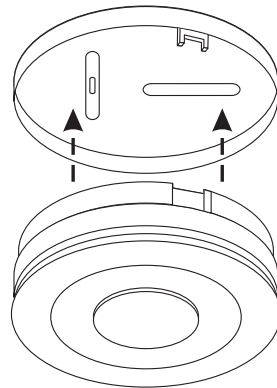

4

TEST ALARM

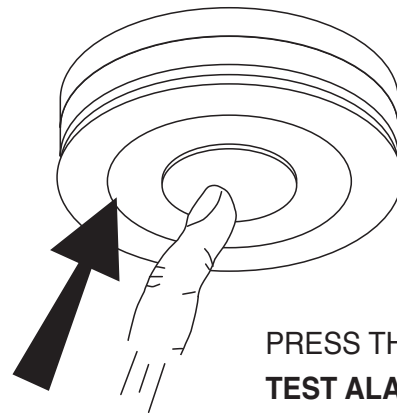

PRESS THE TEST BUTTON
TEST ALARM AT LEAST WEEKLY

2. Location & Positioning

Introduction

Congratulations on purchasing an Ei600 Series Alarm. You can easily install these alarms throughout the property on escape routes, on each storey, in corridors & in closed rooms to give warning of fire.

The Heat Alarms can be installed in kitchens and other areas where Smoke Alarms are unsuitable.

Models Ei605C/Ei603C/Ei605TYC & Ei603TYC can be interconnected with hard wiring to give the loudest alarm sound level throughout the house.

All models (except Ei605 & Ei605TY) can be interconnected using the RadioLINK plug-in modules (These modules must be purchased separately when they are not supplied with the Alarm (see Table 1)).

Note: Certain alarms may be supplied (on request) with the appropriate RF module fitted.

SMOKE ALARMS - Ei605 Series

Sufficient smoke must enter your Smoke Alarm before it will respond. Your Smoke Alarm needs to be within 7.5 metres of the fire to respond quickly. Smoke Alarms also need to be in positions where they can be heard throughout the property, so they can wake you and your family in time for everyone to escape. A single Smoke Alarm will give some protection if it is properly installed, but most homes will require two or more (preferably interconnected) to ensure that a reliable early warning is given. For recommended protection you should put individual Smoke Alarms in all rooms (apart from kitchen and bathroom) where fire is most likely to break out.

Your first Smoke Alarm should be located between the sleeping area and the most likely sources of fire (living room, kitchen for example), but it should not be more than 7.5 metres from the door to any room where a fire may start and block your escape from the house.

HEAT ALARMS - Ei603 Series

The Heat Alarm gives a fire warning when the temperature at the Alarm reaches 58°C. It is ideal for kitchens, garages, boiler houses and other areas where there are normally high levels of fumes, smoke or dust i.e. places where Smoke Alarms cannot be installed without the risk of excessive nuisance alarms. A Heat Alarm should only be used in rooms adjoining escape routes, in conjunction with Smoke Alarms on the escape routes.

All Heat Alarms **must** be interconnected to the Smoke Alarms to ensure that the early warning will be heard, particularly by somebody sleeping. A properly designed early warning fire system ensures the alarm is given before the escape routes become blocked with smoke. Therefore there must be Smoke Alarms along the escape routes as Heat Alarms would not give sufficient warning.

However, a fire in a closed room (e.g. kitchen) adjoining the escape route, can eventually cause the corridor to become smoke-logged due to smoke leaking out from around the door before adequate warning can be given by detectors in the corridor. (Smoke leaking out from a room is often cool and slow moving so it can take a long time to rise to the ceiling, and travel to a detector which could be some distance away). A Heat Alarm in the closed room will give early warning of fire in that room and help overcome this problem.

Multi-Storey Dwellings

If your home has more than one floor, at least one Alarm should be fitted on each level (see Figure 1). Preferably the units should be interconnected (if feature is present on unit) so as to give sufficient warning throughout the property. RadioLINK plug-in modules are ideal in this situation as the units will then interconnect using Radio Frequency (RF) signals - so no wiring is required.

Figure 1 illustrates where Heat Alarms and Smoke Alarms should be located in a typical two storey house. Note the spacings in "Protection Levels" which ensure the early detection of fire and that the warning will be heard.

Locate Heat Alarms in rooms adjoining escape routes - kitchens, garages, boiler houses etc. where Smoke Alarms are unsuitable. Install within 5.3m of potential sources of fire.

Single Storey Dwelling

If the premises is one storey you should put your first Smoke Alarm in a corridor or hallway between the sleeping and living areas. Place it as near to the living area as possible, but make sure that it can be heard loudly enough in the bedroom to wake someone. See Figure 2 for placement example.

In houses with more than one sleeping area, Smoke Alarms should be placed between each sleeping area and the living area and it is recommended that Heat Alarms should be placed in the kitchen & garage.



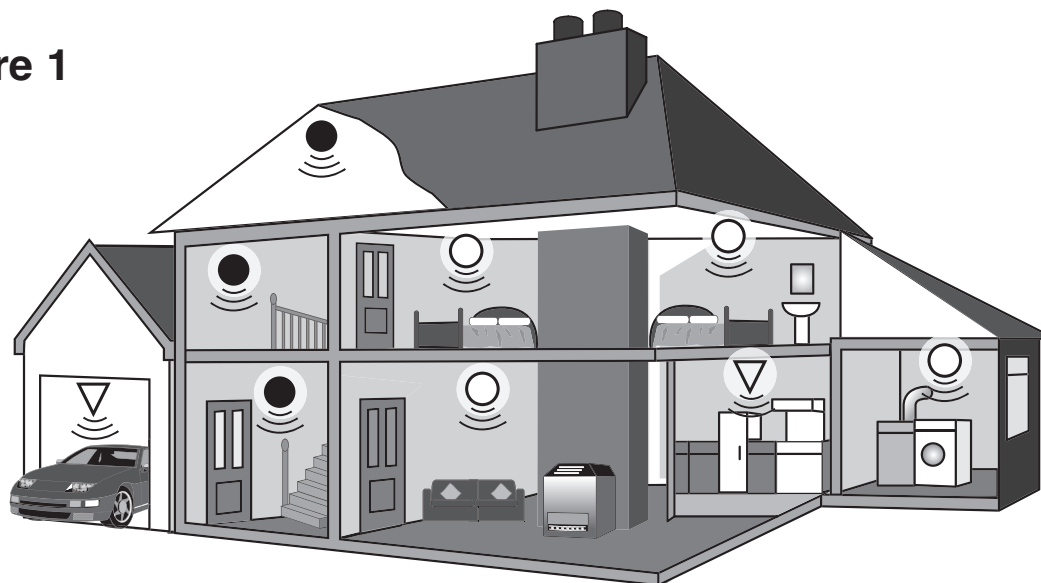

Recommended Protection

Fire authorities recommend you put individual Smoke Alarms in or near all rooms where fire is most likely to break out (apart from the locations to avoid e.g bathrooms - see Section 3). The living room is the most likely place for a fire to start



Figure 1



For minimum protection

-  - Smoke Alarm on each storey
-  - in each sleeping area
-  - every 7.5 metres of hallways and rooms
-  - within 3 metres of all bedroom doors
-  - all units interconnected (where feature is present)

For recommended protection

- (in addition to the above):
-  - Smoke Alarms in every room (except kitchens and bathrooms)
 -  - Heat Alarms located in kitchens, garages etc. within 5.3m of potential fire sources

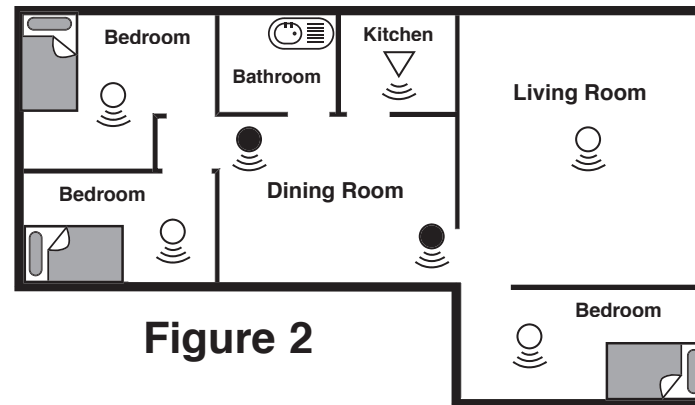

Figure 2

at night, followed by the kitchen (where a Heat Alarm is recommended) and then the dining room. Consideration should be given to installing Smoke Alarms in any bedrooms where fires might occur, for instance, where there is an electrical appliance such as an electric blanket or heater, or where the occupant is a smoker. In addition, consideration should be also given to installing Smoke Alarms in any rooms where the occupant is unable to respond very well to a fire starting in that room, such as an elderly or sick person or a very young child.

Checking Alarms Can Be Heard

With the Alarms sounding in their intended locations check that the alarm can be heard in each bedroom with the door closed, above the sound of any TV/audio systems. The TV/audio systems should be set to a reasonably loud conversation level. If you cannot hear the alarm over the sound of the TV/audio system, the chances are it would not wake you. Interconnecting the Alarms using either a hard-wired interconnection (where the feature is present) or RadioLINK plug-in modules will help to ensure that the alarm will be heard throughout the property.

Positioning

Ceiling Mounting

Hot smoke rises and spreads out, so a central ceiling position is the recommended location. The air is "dead" and does not move in corners, therefore Smoke & Heat Alarms must be mounted away from corners. Keep at least 0.3m from walls and corners (see Figure 3). Additionally, mount the unit at least 0.3m from any light fitting or decorative object which might prevent smoke or heat entering the Smoke/Heat Alarm.

We do not recommend wall mounting these Smoke/Heat Alarms.

On a Sloping Ceiling

With a sloping or peaked ceiling install a Smoke Alarm within 600mm of the peak or a Heat Alarm within 150mm of the peak (measured vertically). If this height is less than 600mm for Smoke Alarms or 150mm for Heat Alarms the ceiling is regarded as being flat (see **Figure 4**).

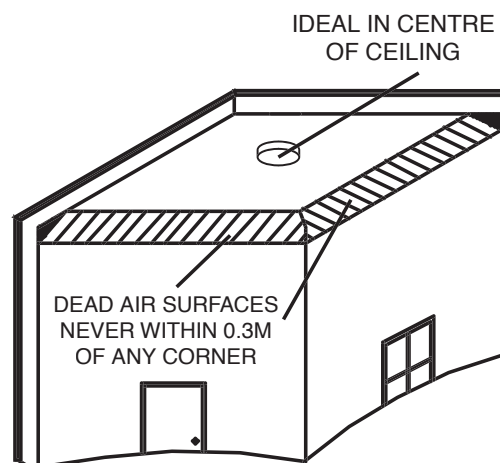

Figure 3

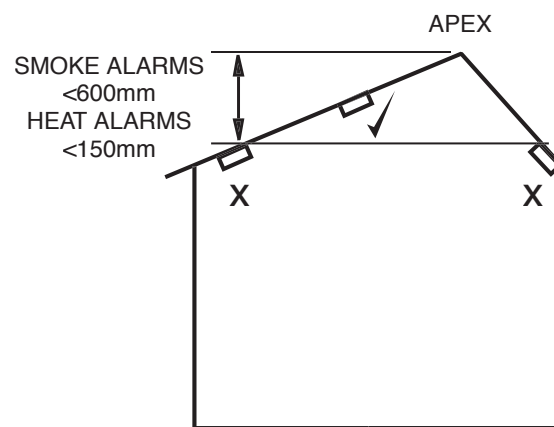
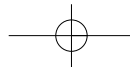

Figure 4

Locations to avoid

DON'T place Smoke Alarms in any of the following areas:

- Bathrooms, kitchens, shower rooms, garages or other rooms where the smoke alarm may be triggered by steam, condensation, normal smoke or fumes. Keep at least 6 metres away from sources of normal smoke/fumes.
- Locate away from very dusty or dirty areas as dust build-up in the chamber can impair performance. It can also block the insect screen mesh and prevent smoke from entering the smoke detector chamber.



- Do not locate in insect infested areas. Small insects getting into the smoke detector chamber can cause intermittent alarms.

DON'T place Heat Alarms in any of the following areas:

- Bathrooms, shower rooms or other rooms where the unit may be triggered by steam or condensation.

DON'T place Smoke or Heat Alarms in any of the following areas:

- Places where the normal temperature can exceed 40°C or be below 0°C (e.g. attics, furnace rooms, directly above ovens or kettles etc.) as the heat/steam could cause nuisance alarms.
- Near a decorative object, door, light fitting, window moulding etc., that may prevent smoke or heat from entering the Alarm.
- Surfaces that are normally warmer or colder than the rest of the room (e.g. attic hatches). Temperature differences might stop smoke or heat from reaching the unit.
- Next to or directly above heaters or air conditioning vents, windows, wall vents etc. that can change the direction of airflow.
- In very high or awkward areas (e.g. over stairwells) where it may be difficult to reach the alarm (for testing, hushing or battery replacement).
- Locate the unit at least 1m from dimmer controlled lights and wiring as some dimmers can cause interference.
- Locate unit at least 1.5m and route wiring at least 1m away from fluorescent light fittings as electrical “noise” and/or flickering may affect the unit.

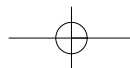
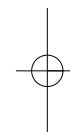
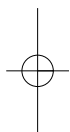

3. Installation

Installation Procedure

1. Select a location complying with the advice in Section 2.
2. Remove the mounting plate from the Smoke/Heat Alarm by twisting it in an anti-clockwise direction (see Figure 5).
3. Place the mounting plate on the ceiling exactly where you want to mount the Alarm. With a pencil, mark the location of the two screw holes.
4. If interconnecting Alarms using hard-wired connections, run suitable twin core cabling to the marked locations of each Alarm. Make the connections to the Alarm (see Section 4).
5. Taking care to avoid any electrical wiring in the ceiling, drill holes using a 5.0mm drill bit through the centre of the marked locations. Push the plastic screw anchors provided into the drilled holes. Screw the mounting plate to the ceiling.

If using RadioLINK Smoke/Heat Alarms then they should be mounted with antennas in the same orientation (i.e. essentially parallel). This means picking



Figure 5

a part of the building, say the front wall of the building and then installing all mounting plates in the same orientation with respect to this (see figure 6).

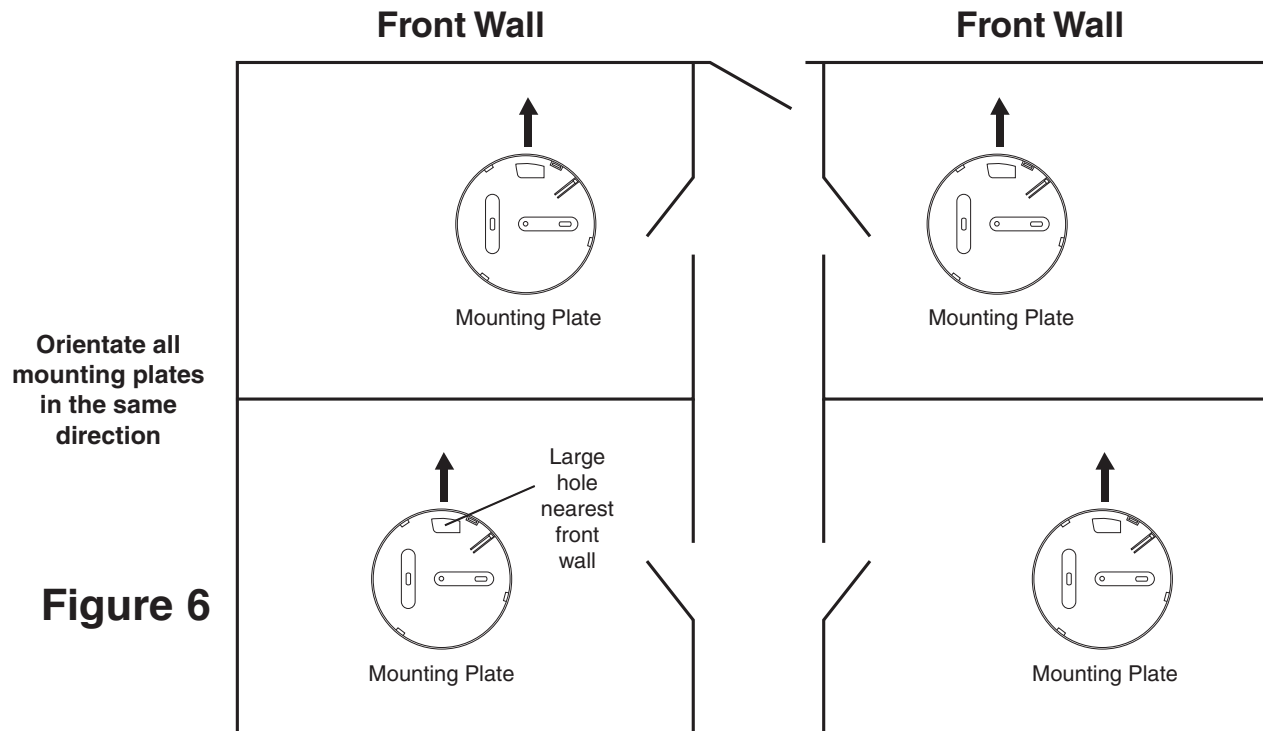

6. Connect the battery to the battery snaps as shown in the **Quick Start Guide** (for **9V Replaceable Battery models** only).

7. Carefully line up the unit on the base, gentle press home & twist on. (This connects the batteries in the **10 Year Lithium Battery models**).

Install all the other Alarms similarly.

8. Press the Test button on each alarm to ensure that the Alarm works (see Figure 7a for Smoke Alarm & 7b for Heat Alarm).

9. For hard-wired interconnected Alarms, hold down the Test button on each Alarm in turn and check that all other interconnected Alarms sound.

10. If using RadioLINK interconnection, see booklet 'RF Modules for Battery Powered Smoke & Heat Alarms.

Install all the other Alarms similarly.

Tamperproofing the Alarms

The Alarm can be made tamperproof to prevent unauthorised removal of the Alarm. Break off the small pillar on the base as shown in figure 8a.

To remove the Alarm from the ceiling it is now necessary to use a small screwdriver, to release the catch (push catch towards the ceiling) and then twist off the alarm (see figure 8b).

If necessary it is possible to further secure the Alarm by using a No.2 or No.4 (2 to 3mm diameter - *not supplied*) self tapping screw 6 to 8mm long (see figure 8d), to firmly lock the Alarm and its mounting plate together (see figure 8c).

Attach the Alarm to the mounting plate.



Smoke Alarm

Figure 7a



Heat Alarm

Figure 7b

BREAK OFF
SMALL PILLAR

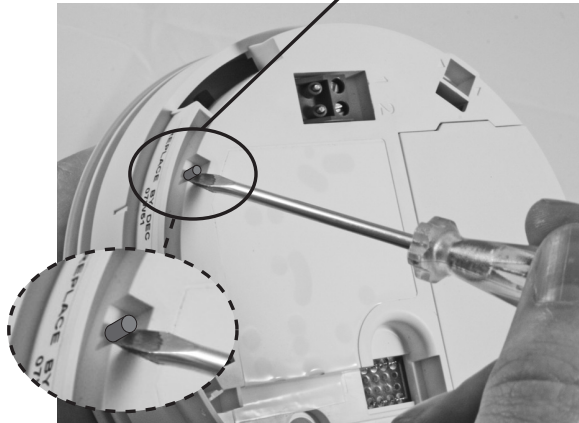

How to Tamperproof
Figure 8a

PUSH UP CATCH & TWIST
ALARM ANTI-CLOCKWISE TO REMOVE



How to Remove
Figure 8b

TAMPERPROOF SCREW

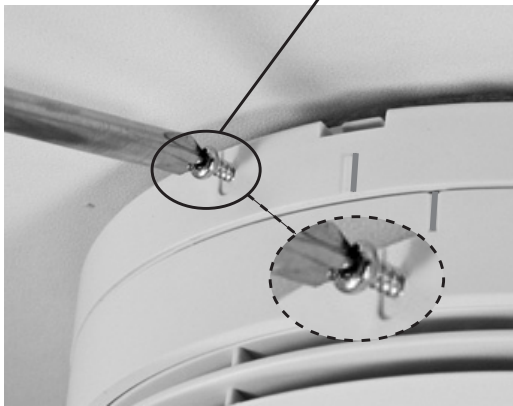

Figure 8c

SELF TAPPING
SCREW

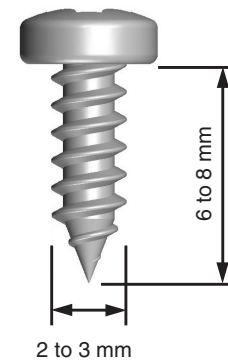

Figure 8d

Line up the screw (not supplied) on the “U” shaped recessed area shown in figure 8c and screw firmly home.

To remove the Alarm from the ceiling, remove the screw first, and then twist off anti-clockwise.

4. Interconnection - Hard Wired

A combined maximum of 12 Smoke Alarms and/or Heat Alarms may be wired together such that when one unit senses fire all other units sound a warning - (see Table 1 for the alarms with hardwired interconnect option). This helps ensure the alarm will be heard throughout the property.

Do not connect to any other device as it may damage the unit or affect performance.



Figure 9a

OPENING IN
MOUNTING PLATE



Figure 9b

A maximum of 250 metres of two core, 0.5mm^2 to 0.75mm^2 , stranded signal cable can be used, (maximum resistance between detectors 50 ohm). The Alarms are interconnected by wiring all the terminals marked 1 together, and all the terminals marked 2 together (see in Figure 9a). Note: Draughts from wiring openings, conduit, or mounting boxes/holes, may blow smoke away

from the sensing chamber, making it insensitive. It is essential that all such ceiling openings be closed with silicone sealant or similar.

1. Run the two core cable to the Alarm locations.
2. Bring the cable through the opening in the mounting plate (before screwing it to the ceiling) see figure 9b.
3. If you are bringing the wiring along the surface, break out the two notches (see figure 10a).
4. Using a small screwdriver, lift off the terminal block by raising it vertically (see figure 10b).
5. Screw the two cable cores into the terminal block (see figure 10b). Then carefully press the terminal block back on to the two pins in the base.
6. Twist the Alarm clockwise on to the mounting plate.

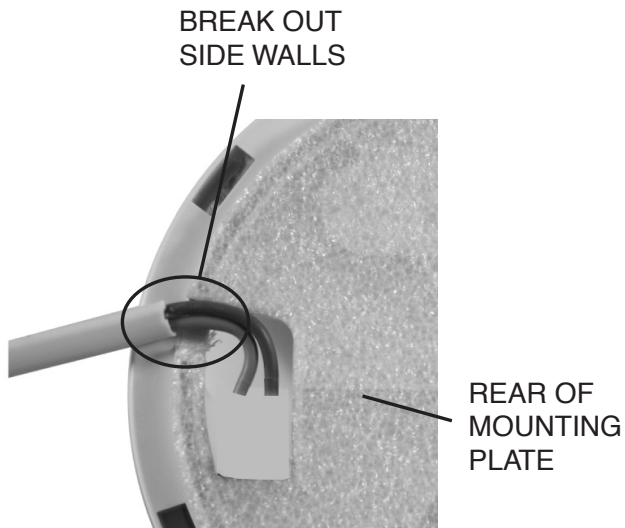

Figure 10a

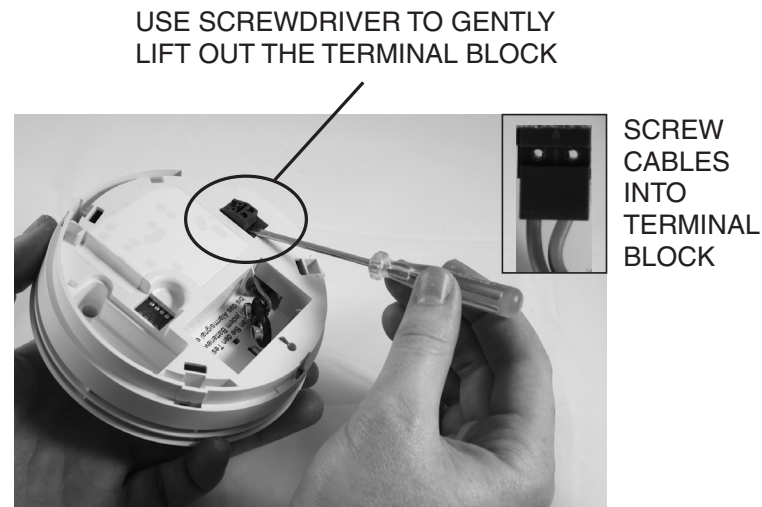

Figure 10b

Install and connect all the other Alarms similarly.

Now test the first Alarm by pressing and holding the Test button (this may take up to 5 seconds). The red indicator light will flash about once a second on the first Alarm and all other Alarms should sound. Check all the other Alarms similarly.

Note: These Alarms should be interconnected only within the confines of a single family living unit. If they are connected between different residences there may be excessive nuisance alarms. Everybody may not be aware that they are being tested or that it is a nuisance alarm caused by cooking etc.

5. Testing, Maintenance & Power Supply Monitoring

Your Alarm is a life saving device and should be checked periodically. Regularly check that the red light on the Alarm flashes approx once a minute to show the units are powered. Replace the Alarm if the flashing stops.

5.1 Manually Testing your Alarms

It is recommended that you test your Alarms after installation and then at least weekly to ensure the units are working. It will also help you and your family to become familiar with the sound of the Alarms.

- Press and hold the Test Button until the Alarm sounds and the red light flashes (see Figure 7a & 7b). The Alarm will stop sounding shortly after the button is released.
- If the Alarms are interconnected using hard-wired connections, check that all interconnected Alarms sound.

- If they are interconnected using RadioLINK modules, hold down the Test button until the blue light on the cover of the Alarm illuminates. Check that all other Alarms sound.
- Release the Test button. The Alarm and all connected Alarms should stop sounding.
- Repeat this procedure for all other Alarms in the system.

WARNING: Do not test with flame.

This can set fire to the Alarm and damage the house. We do not recommend testing with smoke or heat as the results can be misleading unless special apparatus is used.

When you press the Test button it simulates the effect of smoke in a Smoke Alarm and heat in a Heat Alarm which they could experience in a real fire. So, there is no need to test either Alarms with smoke or heat.

5.2 Test/Hush Button to Control Nuisance Alarms

The Smoke Alarms have a combined Test/Hush button to help you control nuisance/false alarms.

If, when the Alarm sounds, there is no sign of smoke or noise to indicate that there is a fire, it should be assumed that it is due to an actual fire and the dwelling should be evacuated immediately.

Check the house carefully in case there is a small fire smouldering somewhere.

Check whether there is some source of smoke or fumes, for example cooking fumes being drawn past the Alarm by an extractor.

If there are frequent nuisance/false alarms it may be necessary to re-locate the Smoke Alarm away from the source of the fumes.

If you installed Alarms with RadioLINK modules and did not House Code them, you may be receiving alarm signals from a neighbouring system. This can be easily rectified by “House Coding” your Alarms - see booklet ‘RF Modules for Battery Powered Smoke & Heat Alarms.

1. To cancel a false alarm from a Smoke Alarm (which has its red light flashing rapidly), press the Test/Hush button (the Smoke Alarm will automatically switch to a reduced sensitivity condition).

The Smoke Alarms will be silenced for a period of approximately 10 minutes. The red light on the cover of the Smoke Alarm will flash every 10 seconds (instead of 40 seconds) to indicate that the unit has been silenced.

2. The Smoke Alarm will reset to normal sensitivity at the end of the silenced period (10 minutes). If additional silenced time is required, simply push the Test/Hush button again.

3. If kitchen usage/layout is such that there are an unacceptable level of nuisance alarms, re-locate the Smoke Alarm further away where it will be less affected by cooking fumes etc. We recommend the use of a Heat Alarm in the Kitchen area to avoid such nuisance alarms.

5.3 Power Supply Monitoring

5.3.1 What to do when an Alarm is beeping:

1. A Smoke Alarm is beeping about every 40 seconds with the red light flashing at the same time:

- If it is a **9V Replaceable Battery model** then replace the battery.
- If it is a **10 Year Lithium Battery model** then replace the entire unit.

2. A Heat Alarm is beeping about every 40 seconds.

- If it is a **9V Replaceable Battery model** then replace the battery.
- If it is a **10 Year Lithium Battery model** then replace the entire unit.

3. On 10 Year Lithium Battery models with RadioLINK modules (fitted) - If the blue light flashes every 10 seconds it indicates that the RF battery is depleted and the RadioLINK module must be replaced.

5.3.2 Battery Replacement - (**9V Replaceable Battery models** only)

A fresh Alkaline Battery should last for over a year. When the battery power is low and replacement is necessary, the Smoke Alarm will “beep” and the red light will flash at the same time about once per minute for at least 30 days. The Heat Alarm will also beep once per minute, but the red light will **not** flash at the same time when the battery is low. The battery must then be replaced. Also, replace the battery if the Alarm does not sound when the Test Button is pressed. For maximum reliability, replace the battery at least once a year. When you replace the battery you must press the Test button to check that the Alarm is functioning correctly. Only replace the battery with one of the following alkaline batteries: Duracell MN1604, Energizer 6LR61, Philips 6LR61, Varta 6LR61 or the Ultralife U9VL-J lithium battery. The lithium battery will last longer than an alkaline battery.

All Models: Prolonged exposure to low or high temperatures or high humidity may reduce battery life. Prolonged periods of alarm will also reduce battery life.

5.3.3 RadioLINK Module Units

If all the RadioLINK Alarms sound for 2 seconds every 4 hours, it means at least one of the Alarms in the system has a depleted battery. Locate the depleted battery(ies) as above.

5.4 Cleaning your Alarm

Clean your Alarm regularly. Use a soft bristle brush or the brush attachment of your vacuum cleaner to remove dust and cobwebs from the side slots where the smoke/heat enters. To clean the cover, wipe with a damp cloth and dry thoroughly.

WARNING: Do not paint your Alarm.

Other than the maintenance and cleaning described in this leaflet, no other customer servicing of this product is required. Repairs, when needed, must be performed by the manufacturer.

5.5 Smoke Alarm Automatic Self-Test

The smoke chamber in the Smoke Alarms automatically tests itself every 40 seconds. If the chamber is degraded it will beep without the red light flashing at the same time. If this happens clean the unit. If the beeping persists and the beep does not coincide with a red light flash, return the unit for service (see Section 9 - Getting your Smoke Alarm Serviced).

5.6 Dust & Insect Contamination

All Smoke Alarms and particularly the optical (photoelectric) type are prone to dust and insect ingress which can cause false alarms. (Heat Alarms are not as susceptible to dust and contamination as Smoke Alarms, but it is prudent to clean them periodically).

The latest design, materials and manufacturing techniques have been used in the construction of Ei Electronics Alarms to minimise the effects of contamination. However it is impossible to completely eliminate the effect of dust and insect contamination, and therefore, to prolong the life of the Alarm you must ensure that it is kept clean so that excess dust does not build up. Any insects or cobwebs in the vicinity of the Smoke Alarm should be promptly removed.

In certain circumstances even with regular cleaning, contamination can build up in the smoke sensing chamber causing the alarm to sound. If this happens the Smoke Alarm must be returned for servicing or replacement. Contamination is beyond our control, it is totally unpredictable and is considered normal wear and tear. For this reason, contamination is not covered by the guarantee and a charge is made for all such servicing work.

5.7 End of life

The entire Alarm must be replaced if:-

(i) All Models:

- The unit is installed for over 10 years (check the “replace by” date marked on the side of the unit).

(ii) All **10 Year Lithium Battery models** only

- The Smoke Alarm is giving a short beep about every 40 seconds and the red light flashes at the same time for longer than 1 hour. The Heat Alarm is giving a short beep about every 40 seconds for longer than 1 hour.
- The Alarm fails to sound the horn loudly when the test button is pressed.

Before the Alarm is safely discarded, remove from the mounting plate. With the **9V Replaceable Battery models** disconnect the battery.

Do not put the Alarm into a fire.

The Alarm should be disposed in a safe and environmentally sound manner at your local recycle centre. Contact your local authority for further advise.

6. Fire Safety Advice

When using household protective devices, basic safety precautions should always be followed, including those listed below

- Please read all instructions.
- Rehearse emergency escape plans so everyone at home knows what to do in case the alarm sounds.
- Use the Alarm Test Button to familiarise your family with the Alarm sound and to practice fire drills regularly with all family members. Draw up a floor plan that will show each member at least 2 escape routes from each room in the house. Children tend to hide when they don't know what to do. Teach children how to escape, open windows, and use roll up fire ladders and stools without adult help. Make sure they know what to do if the alarm goes off.
- Constant exposure to high or freezing temperatures, high humidity or a high level of nuisance alarms may reduce the life of the battery.
- Nuisance alarms can be quickly silenced by fanning vigorously with a newspaper or similar to remove the smoke or press the test / hush button.
- Do not attempt to remove, recharge or burn the battery, as it may explode.
- If it is necessary to remove the battery for separate disposal, handle carefully to avoid possible eye damage or skin irritation if battery has leaked or corroded.
- To maintain sensitivity to smoke/heat, do not paint or cover the Alarm in any manner; do not permit any accumulation of cobwebs, dust or grease.

- If Alarm has been damaged in any way or does not function properly, do not attempt a repair. Return the Alarm (see Section 9).
- This appliance is intended ONLY for premises having a residential type environment.
- This is not a portable product. It must be mounted following the instructions in this instruction leaflet.
- Smoke/Heat Alarms are not a substitute for insurance. The supplier or manufacturer is not your insurer.

Fire Safety Hints

Store petrol and other flammable materials in proper containers.

Discard oily or flammable rags.

Always use a metal fireplace screen and have chimneys cleaned regularly.

Replace worn or damaged sockets, switches, home wiring and cracked or frayed electrical cords and plugs.

Do not overload electrical circuits.

Keep matches away from children.

Never smoke in bed. In rooms where you do smoke, always check under cushions for smouldering cigarettes and ashes.

Service central heating systems regularly.

Be sure all electrical appliances and tools have a recognised approval label.

This device cannot protect all persons at all times. It may not protect against the three most common causes of fatal fires:

1. Smoking in bed.
2. Leaving children at home alone.
3. Cleaning with flammable liquids, such as petrol.

Further information can be obtained from the Fire Brigade.

Planning Your Escape Route For When The Alarms Sound

1. Check room doors for heat or smoke. Do not open a hot door. Use an alternate escape route. Close doors behind you as you leave.

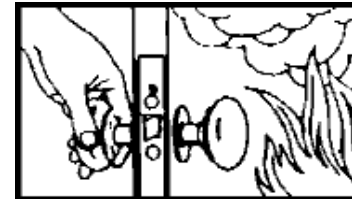

2. If smoke is heavy, crawl out, staying close to floor. Take short breaths, if possible, through a wet cloth or hold your breath. More people die from smoke inhalation than from flames.



3. Get out as fast as you can. Do not stop for packing. Have a prearranged meeting place outside for all family members. Check everybody is there.



4. Call the Fire Brigade from a neighbour's house or mobile phone. Remember to give your name and address.



5. **NEVER** re-enter a burning house.



7. Alarm Limitations

Limitations of Smoke/Heat Alarms

Smoke/Heat Alarms have significantly helped to reduce the number of fire fatalities in countries where they are widely installed. However independent authorities have stated that they may be ineffective in some circumstances. There are a number of reasons for this:

- Smoke/Heat Alarms will not work if the batteries are depleted or if they are not connected. Test regularly and replace the entire Alarm when it fails to operate.
- Smoke/Heat Alarms will not detect fire if sufficient smoke or heat does not reach the Alarm. Smoke/Heat may be prevented from reaching the Alarm if the fire is too far away, for example, if the fire is on another floor, behind a closed door, in a chimney, in a wall cavity, or if the prevailing air draughts carry the smoke or heat away. Installing Smoke/Heat Alarms on both sides of closed doors and installing more than one Alarm

as recommended in this leaflet very significantly improve the probability of early detection.

- The Smoke/Heat Alarm may not be heard.
- RadioLINK may not work due to interference or due to the signal being blocked by furniture, renovations etc.
- A Smoke/Heat Alarm may not wake a person who has taken drugs or alcohol.
- The Alarms may not detect every type of fire to give sufficient early warning. They are particularly ineffective with: fires caused by smoking in bed, escaping gas, violent explosions, poor storage of flammable rags and/or liquids, (for example petrol, paint, spirits etc), overloaded electrical circuits, arson, children playing with matches.
- Smoke/Heat Alarms don't last indefinitely. We recommend replacement after 10 years as a precaution.

Alarm Limitations

8. RadioLINK Accessories

Ei605MRF RadioLINK Interconnect module for the **9V Replaceable Battery models**. It plugs into the rear of the Alarm. This ensures that when one Alarm senses fire, all units sound to give an alarm through-out the house - (see Table 1).

Ei605MTYRF RadioLINK Interconnect module for the **10 Year Lithium Battery models**. It plugs into the rear of the Alarm. This ensures that when one Alarm senses fire, all units sound to give an alarm through-out the house - (see Table 1).

9. Getting Your Alarm Serviced

If your Alarm fails to work after you have read the sections on “Installation”, “Testing and Maintenance” and “Troubleshooting”, then contact Customer Assistance at the nearest address given at the end of this leaflet. If it needs to be returned for repair or replacement put it in a padded box with the battery disconnected (**9V Replaceable Battery models** only). The **10 Year Lithium Battery models** must be removed from the mounting plate. Send it to “Customer Assistance” at the nearest address given on the Alarm or in this leaflet. State the nature of the fault, where the Alarm was purchased and the date of purchase.

10. Five Year Guarantee

Ei Electronics guarantees this Alarm (excluding the battery in the **9V Replaceable Battery models**) for five years from date of purchase against any defects that are due to faulty materials or workmanship. This guarantee only applies to normal conditions of use and service, and does not include damage resulting from accident, neglect, misuse, unauthorised dismantling, or contamination howsoever caused. This guarantee excludes incidental and consequential damage. If this Alarm should become defective within the guarantee period, it must be returned to Ei Electronics, with proof of purchase, carefully packaged, with the problem clearly stated (see Section 9). We shall at our discretion repair or replace the faulty unit.

Do not interfere with the Alarm or attempt to tamper with it. This will invalidate the guarantee, but more importantly may expose the user to shock or fire hazards.

This guarantee is in addition to your statutory rights as a consumer.

11. Troubleshooting

Alarms sound for no apparent reason

- House Code your Alarms - see booklet 'RF Modules for Battery Powered Smoke & Heat Alarms'. If the Alarms are in the default factory settings, neighbouring units may cause them to alarm.
- Check for fumes, steam, etc. from the kitchen or bathroom. Paint and other fumes can cause nuisance alarms.
- Check for any sign of contamination such as cobwebs or dust. Clean the alarm as described in Section 5 if necessary.
- Press the Test/Hush button on the Smoke Alarm causing the Alarm (this can be identified as the Alarm with the red light flashing rapidly) – this will silence the Smoke Alarm for 10 minutes (and also silence all other interconnected Alarms in the system).
- Smoke & Heat Alarms, with RadioLINK modules, sound for 2 seconds every 4 hours - this indicates that there is a depleted battery somewhere in the system - check all Alarms as outlined in section 5 "Power Supply Monitoring".

The Alarm fails to sound when the Test button is pressed

- Check the age of the unit - see the "replace by" label on side of unit.
- Check the battery snaps are firmly connected on the **9V Replaceable Battery models**.

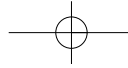

- On the **10 Year Lithium Battery models** ensure the unit is twisted fully home on the mounting plate, as this connects the battery.



Troubleshooting

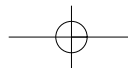

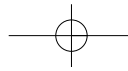

The crossed out wheelie bin symbol that is on your product indicates that this product should not be disposed of via the normal household waste stream. Proper disposal will prevent possible harm to the environment or to human health. When disposing of this product please separate it from other waste streams to ensure that it can be recycled in an environmentally sound manner. For more details on collection and proper disposal, please contact your local government office or the retailer where you purchased this product.

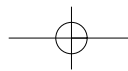
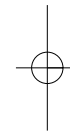
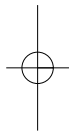

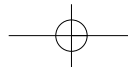

Construction Product Type: **Smoke Alarm Devices**
European Standard: **EN14604:2005**
Certificate of Conformity: **0086-CPD-537430**

MODEL	TYPE
Ei605	Optical Smoke Alarm
Ei605C	Optical Smoke Alarm
Ei605W	Optical Smoke Alarm
Ei605TY	Optical Smoke Alarm
Ei605TYC	Optical Smoke Alarm
Ei605TYW	Optical Smoke Alarm



0086

08

The Smoke Alarms are Tested & Approved to EN14604:2005 by the German Fire Laboratory VdS and the Heat Alarms are Tested & Approved to BS5446-2:2003 by the British Standards Institute

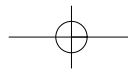

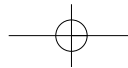

12. Contact Us

Aico Ltd. Mile End Business Park, Maesbury Rd, Oswestry,
Shropshire SY10 8NN, U.K.

Tel: 0870 758 4000

www.aico.co.uk

Ei Electronics. Shannon, Co Clare, Ireland. Tel: 061 471277

www.eielectronics.com

