



**PERKO**  
**POWERMATIC®**  
THE THIRD GENERATION CONCEALED DOOR CLOSER

Controlled  
Concealed  
Door Closer



1121



**CERT FIRE**

CF370

**SAMUEL HEATH**

for a life less ordinary

# Key features

- **CE** marked ✓
- Type tested to **BS EN 1154: 1997** power size 3 for doors up to 80Kg in weight and up to 950mm wide ✓
- Opening forces comply with the requirements of **Approved Document M** for doors of a minimum width of 826mm whilst still conforming to BS EN 1154: 1997 ✓
- **80% “ultra-efficiency”** exceeds the recommendation (65%) for fire doors on accessible routes ✓
- BS EN 1634-1:2000 approved for use on half-hour and one-hour fire doors ✓
- Suitable for latched and unlatched installations ✓
- Adjustable closing speed and power latching action ✓
- Certifire approved ✓
- 10-year guarantee ✓
- Factory production control to BS EN ISO 9001: 2000 ✓
- Endurance tested to 500,000 closing cycles ✓
- Unique twin power mechanism ✓
- Protected by worldwide patents ✓
- On-site technical advice ✓

**Controlled, concealed and  marked**

# PERKO **POWERMATIC**<sup>®</sup>

THE THIRD GENERATION CONCEALED DOOR CLOSER

Perko Powermatic<sup>®</sup> is the third jamb mounted concealed door closer to be developed by us and is without doubt our most significant innovation to date, creating one of the most versatile ranges of door closers available.

Building on the heritage of the Perko<sup>®</sup> and Perkomatic<sup>®</sup>, which have been closing doors in a wide variety of buildings for over 30 years, Perko Powermatic<sup>®</sup> is the result of many years of intensive research and development, ensuring that the key attributes of quality, reliability and attention to detail are maintained.

Perko Powermatic<sup>®</sup> is a CE marked, controlled, concealed hydraulic door closer conforming to BS EN 1154: 1997 power size 3, making it ideal for many commercial, leisure, public and domestic fire door applications.

Available with solid brass end plates in brass, chrome and satin chrome finishes, yet **invisible** when the door is closed, Perko Powermatic<sup>®</sup> offers the ultimate in door control without the need to compromise on the appearance of the door itself or the aesthetics of the finished project.

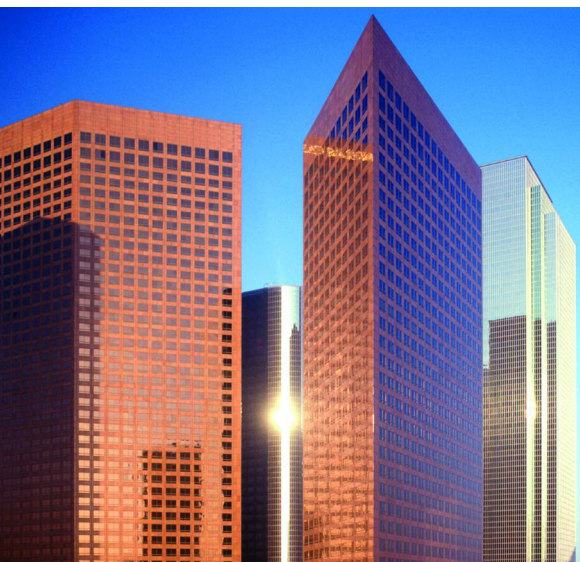
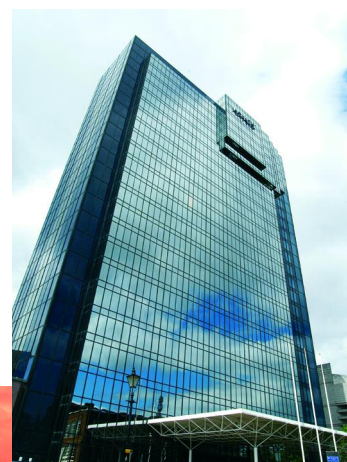
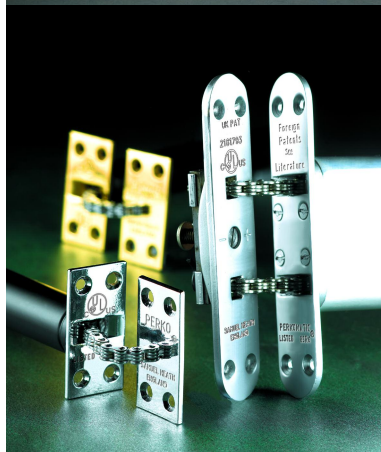



# FULLY CONCEALED WHEN THE DOOR IS CLOSED

Only the machined end plates and links can be seen when the door is open

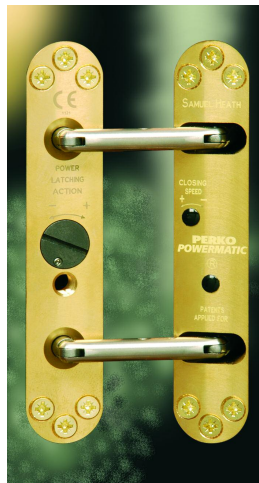
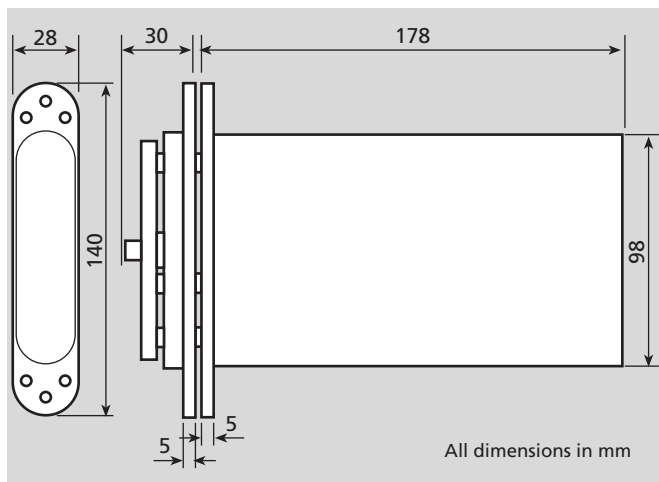
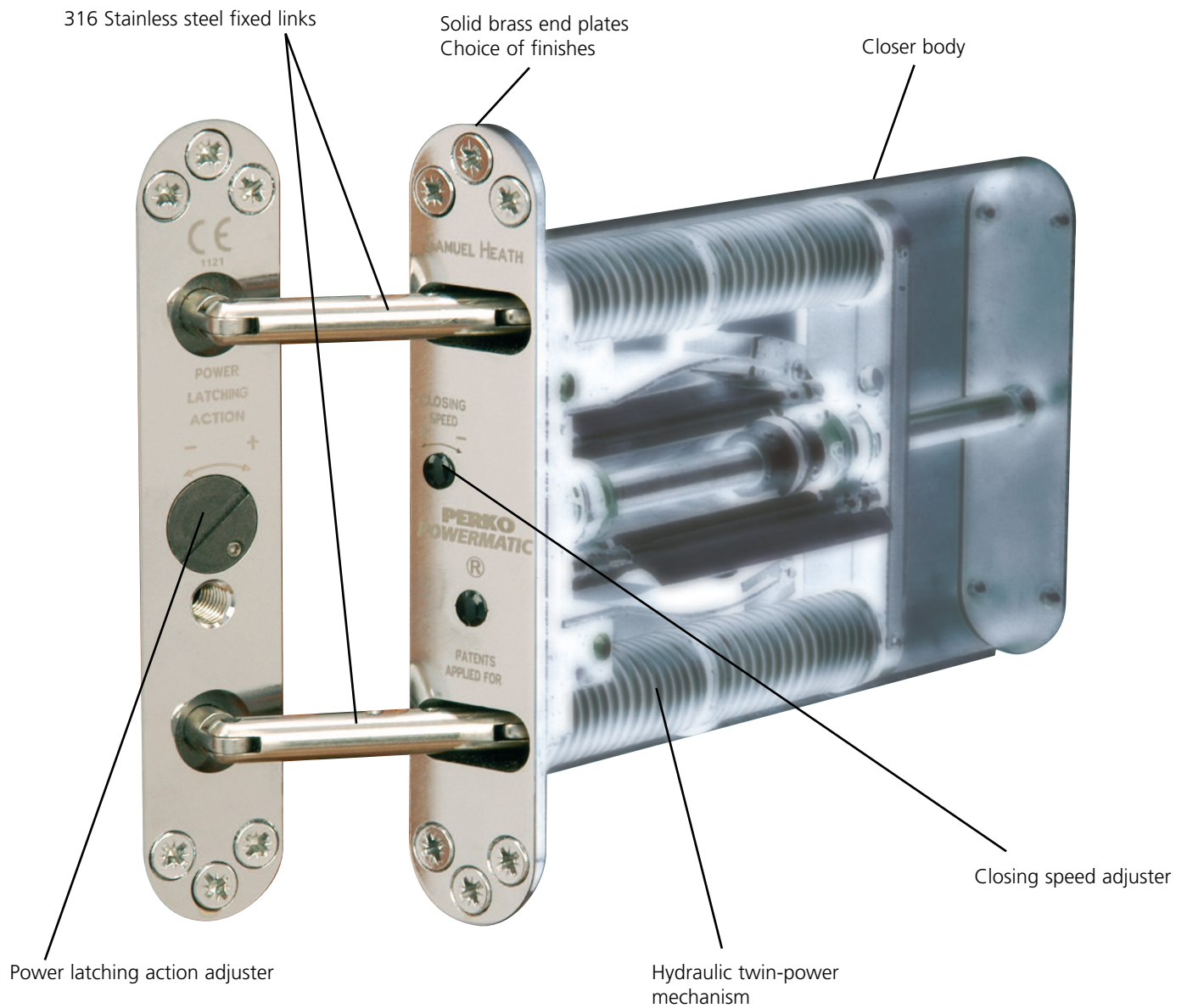

**R100**  
Brass



**R100.CP**  
Chrome plated

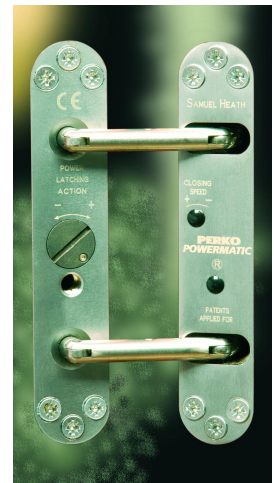

**R100.SCP**  
Satin chrome plated

# Fire and performance

Perko Powermatic® has a unique twin-power mechanism that possesses the necessary force to provide controlled closing of doors up to 80kg in weight and 950mm wide.

Perko Powermatic® meets the performance requirements of BS EN 1154: 1997 for power size 3 controlled door closers and has been endurance tested in excess of 500,000 closing cycles. Together with successful fire testing to BS EN 1634-1 and factory production control to BS EN ISO 9001: 2000, this outstanding performance and durability qualifies Perko Powermatic® to carry the CE mark.

Further assurance is delivered in the form of Certifire approval, all of which makes Perko Powermatic® an excellent choice for a wide variety of fire door applications.



1121



CF370



ISO 9001  
FM 09441

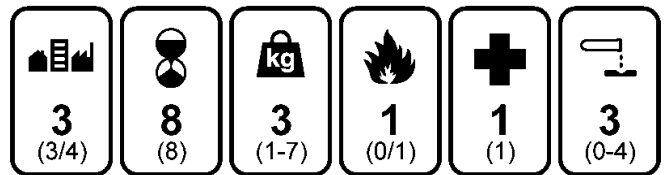

Product classification to BS EN 1154: 1997 Power size 3  
Full details on classification system can be found at [www.abhm.org.uk](http://www.abhm.org.uk).



## Technical support

Detailed information on Perko Powermatic® and copies of certificates are available on our website at [www.perko-powermatic.com](http://www.perko-powermatic.com).

Perko Powermatic® is supported by a comprehensive on-site representation and advisory service. Technical advice is available at all stages of the specification and installation process, providing you with total assurance in product selection and application.

Samuel Heath has been supplying discerning customers with the very best in product design and innovation for almost two centuries, establishing a reputation for quality and service throughout the world.

Combining traditional craftsmanship and attention to detail with the latest design and manufacturing techniques, Samuel Heath has created some of the most attractive solid brass fittings to grace any home. The quality, performance and durability of the entire range of Samuel Heath products have made them equally suitable for commercial, domestic and leisure developments across the globe.

In addition to Perko®, Perkomatic® and Perko Powermatic® concealed door closers, Samuel Heath's extensive range of high quality, solid brass products includes complementary suites of bathroom accessories, taps and showers, in a variety of finishes together with an extensive collection of door and window fittings.

Further details on Perko Powermatic® and other Samuel Heath products can be obtained from the company's websites or sales office at the contact addresses listed below.

## SAMUEL HEATH & SONS PLC

Leopold Street, Birmingham B12 0UJ, England

Telephone: 0121 772 2303 Fax: 0121 772 3334

**Sales Office Direct Line: 0121 766 4200**

International Telephone: +44 121 772 2303 International Fax: +44 121 772 3334

e-mail: [info@samuel-heath.com](mailto:info@samuel-heath.com)

**[www.samuel-heath.com](http://www.samuel-heath.com)**

e-mail: [powermatic@samuel-heath.com](mailto:powermatic@samuel-heath.com)

**[www.perko-powermatic.com](http://www.perko-powermatic.com)**

© SAMUEL HEATH & SONS PLC. 2007

All material and illustrations included in this catalogue are the copyright of Samuel Heath & Sons Plc and cannot be used without prior written permission in any other publication, advertisement, correspondence, catalogue or brochure in any medium whatsoever, whether written or electronic, including the internet.

*Samuel Heath have a policy of continual improvement in the design and performance of its products.*

*The right is therefore reserved to vary specification without notice.*