

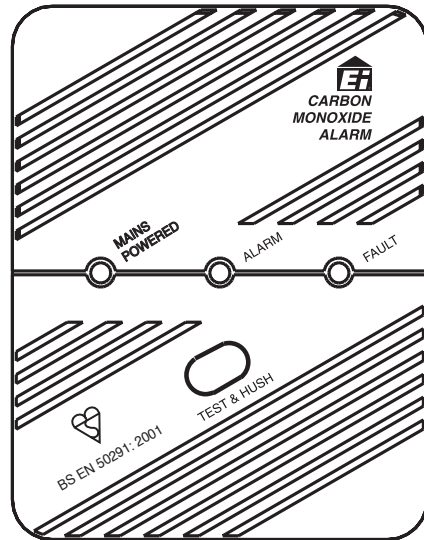

MAINS POWERED CARBON MONOXIDE ALARM



Model Ei 225EN - HARD WIRED TO MAINS

Model Ei 220EN - WITH POWER CORD

Read and retain carefully for as long as the product is being used. It contains vital information on the operation and installation. The leaflet should be regarded as part of the product.

If you are just installing the unit, the leaflet must be given to the householder. The leaflet is to be given to any subsequent user.

INSTRUCTIONS

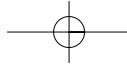

CONTENTS		Page
1	READ THIS FIRST	3
2	WHAT TO DO WHEN THE CO ALARM SOUNDS	4
3	CARBON MONOXIDE - THE SILENT KILLER!	5
4	WHERE TO PLACE CARBON MONOXIDE ALARMS	11
5	INSTALLING YOUR CARBON MONOXIDE ALARMS	15
6	TESTING YOUR CARBON MONOXIDE ALARMS	19
7	MAINTAINING CARBON MONOXIDE ALARMS	20
8	LIMITATIONS OF CARBON MONOXIDE ALARMS	22
9	HOW TO PROTECT YOUR FAMILY	24
10	TECHNICAL SPECIFICATIONS	26
11	GETTING YOUR CARBON MONOXIDE ALARMS SERVICED	28
12	GUARANTEE	28
13	TROUBLESHOOTING	30

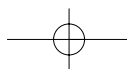
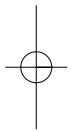

1. READ THIS FIRST

WARNING: The Ei225EN Alarm should be permanently wired to the mains by a qualified electrician in accordance with IEE wiring regulations (BS7671).

- The Ei220EN is just plugged in to the mains.
- Install the Carbon Monoxide Alarm (CO Alarm) in every room that contains a fuel burning appliance, particularly rooms where people spend a lot of time e.g. bedrooms, kitchens and sitting rooms.
- In rooms with an appliance install (preferably) on the ceiling, (300mm from walls), and between 1m to 3m horizontally from appliance. In rooms remote from the appliance install at breath level, where the light indicators can be seen.
- Regularly check that the green power light is on. **Important:** The CO Alarm will not work if the mains supply is off.
- Test the unit weekly by pressing the test/hush button-the horn will sound.
- Open the unit by sliding the cover up as shown in figure 1. Then remove the terminal block screw. (Ei225EN only).
- Immediately the unit is powered the green light will turn on & the red & amber lights will flash once to show they are operational.
- Replace unit after up to 6 years operation (see 'Replace by' date on sidewall label).

- When the CO Alarm detects abnormal levels of CO (above 50ppm CO) the **red light** starts to flash and the horn will sound within 90 minutes. At higher levels of CO the alarm will turn on sooner (see table B - page 9).
- The CO Alarm will automatically reset once the CO has cleared. Pressing the test/hush button resets the CO Alarm immediately (below 300ppm CO). If CO is still present the red light and horn will turn on again after about 4 minutes.
- The CO Alarm is no substitute for keeping chimneys and flues clear and in good condition, and all of your appliances serviced regularly according to the manufacturers' instructions.
- Do not fit alarm until all building work is completed to avoid contamination.

2. WHAT TO DO WHEN THE ALARM SOUNDS

- (1) Open the doors and windows to ventilate the area.
- (2) Turn off all fuel appliances where possible and stop using them. (The alarm can be silenced immediately by pushing the test/hush button).
- (3) Evacuate the property leaving the doors and windows open.
- (4) Get medical help immediately for anyone suffering the effects of Carbon Monoxide poisoning (headache, nausea), and advise that Carbon Monoxide poisoning is suspected.

(5) Ring your gas or other fuel supplier on their emergency number. Keep the number in a prominent place.

(6) Do not re-enter the property until the alarm has stopped. (If the alarm has been silenced by pressing the test/hush button, wait at least 5 minutes so the alarm can check that the CO has cleared).

(7) Do not use the fuel appliances again until they have been checked by an expert. In the case of gas appliances this must be a CORGI registered installer.

3. CARBON MONOXIDE - THE SILENT KILLER!

2.1 What is Carbon Monoxide ?

Congratulations on becoming the owner of an Ei Carbon Monoxide Alarm. This will help protect you and your household from the dangerous effects of Carbon Monoxide - the silent killer. (CO is the chemical symbol, indicating the molecule has one carbon atom and one oxygen atom).

Many are killed each year, and many more suffer ill health from Carbon Monoxide

Figure 1 - Alarm Installation

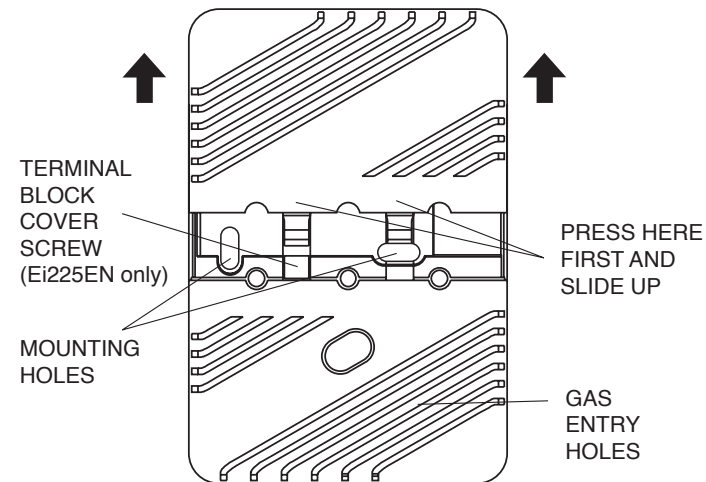

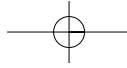

(CO) poisoning. CO is an invisible, odourless, tasteless and extremely toxic gas. It is produced by appliances and vehicles burning fuels, such as coal, oil, natural/bottled gas, paraffin, wood, petrol, diesel, charcoal etc. CO is absorbed by red blood cells in the lungs in preference to oxygen - this results in rapid damage to the heart and brain from oxygen starvation.

High levels of CO in a house can be caused by:

- Incorrectly or poorly installed fuel-burning appliances.
- Blocked or cracked chimneys/flues.
- Blocked vents or draught-proofing which makes areas with fuel burning appliances or fireplaces airtight.
- Engines of cars, lawnmowers etc. left running in confined spaces.
- Portable paraffin or gas heaters in badly ventilated rooms.

2.2 Symptoms of Carbon Monoxide Poisoning

Most people know that high levels of CO are harmful, however the period of exposure is also important.

The following symptoms are related to Carbon Monoxide poisoning and should be discussed with all members of the household.

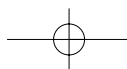

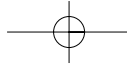

Mild Exposure: Slight headache, nausea, vomiting, fatigue (often described as “flu-like” symptoms).

Medium Exposure: Severe throbbing headache, drowsiness, confusion, fast heart rate.

Extreme Exposure: Unconsciousness, convulsions, cardiorespiratory failure, death. A high level of CO for a short period (e.g. 350 ppm CO for 30 minutes) will cause the same symptoms, a slight headache, as a lower level for a longer time (e.g. 150 ppm for 90 minutes). Table A shows how exposure to different concentrations of CO generally affects people.

Many cases of reported Carbon Monoxide poisoning indicate that while victims are aware they are not well, they become so disorientated they are unable to save themselves by either leaving the building or calling for assistance. Young children and household pets may be the first affected.

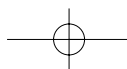
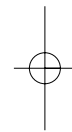
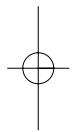

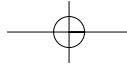

Table A: Effects of Carbon Monoxide Poisoning

Concentration of CO in Air ▲ ppm	Inhalation Time (approx) and Symptoms Developed
35	The maximum allowable concentration for continuous exposure in any 8 hour period according to OSHA *.
150	Slight headache after 1.5 hours.
200	Slight headache, fatigue, dizziness, nausea after 2-3 hours.
400	Frontal headaches within 1-2 hours, life threatening after 3 hours, also maximum parts per million in flue gas (on an air free basis) according to US Environmental Protection Agency.
800	Dizziness, nausea and convulsions within 45 minutes. Unconsciousness within 2 hours. Death within 2-3 hours.
1,600	Headache, dizziness and nausea within 20 minutes. Death within 1 hour.
3,200	Headache, dizziness and nausea within 5-10 minutes. Death within 25-30 minutes.
6,400	Headache, dizziness and nausea within 1-2 minutes. Death within 10-15 minutes.
12,800	Death within 1-3 minutes.

▲ ppm = parts per million

*OSHA Occupational Safety & Health Association

2.3 What happens when your CO Alarm detects Carbon Monoxide ?

When the Alarm detects potentially dangerous levels of CO, it flashes the red alarm light and then sounds a loud alarm if the CO persists.

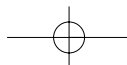

Table B shows how the CO Alarm reacts to different levels of CO gas and exposure time. At higher levels of CO the alarm turns on sooner. The rate of flashing of the red light indicates the level of CO.

Table B: CO Alarm Response

CO Level ppm	Red Alarm Light	Horn On within
0 ppm	Off *	Off
50ppm	1 Flash / 2 Seconds	60 to 90 minutes
100 ppm	4 Flashes / 2 Second	10 to 40 minutes
300 ppm	8 Flashes / 2 Second	3 minutes

* unless it has been in alarm (see CO Alarm Memory below)

If your CO Alarm sounds follow the instructions on page 4.

When ventilation is provided by leaving the window and doors open, the CO build up may have dissipated by the time help arrives and the alarm may have stopped sounding. Although your problem may appear temporarily solved it is crucial that the source of the CO is determined and appropriate repairs made.

NEVER IGNORE THE ALARM.

Pre-Alarm: When the alarm detects over 50ppm CO the red light flashes every 2 seconds. This helps locate CO leaks, as the unit gives an indication straight away.

(Without this feature the CO level would need to be at 50ppm CO for 90 minutes for an indication to be given). Note the Pre-Alarm signal may be triggered by CO coming for example, from cooking with gas, from car engines or from nearby barbecues. This is usually not a concern unless the Pre-Alarm signal persists until the alarm sounds and the CO source is unknown.

NOTE: The CO Alarm may sound if cigarette smoke is blown into it, or aerosols are released nearby.

CO ALARM MEMORY

- **Red light is Off** – No CO detected since reset or power up.
- **Red light flashes 2 times** (in 2 seconds) every 40 seconds, 50 ppm CO detected for least about 90 minutes.
- **Red light flashes 4 times** (in 2 seconds) every 40 seconds, 100 ppm CO detected for least about 40 minutes.
- **Red light flashes 8 times** (in 2 seconds) every 40 seconds, 300 ppm CO detected for at least about 3 minutes.

When the test button is pressed the horn will sound, and the red light will only flash if the unit has previously detected CO and been in alarm. The flash rate indicates the level of CO detected as in table B.

Reset Memory by holding down the test button for over 20 seconds until the red light stops flashing. Cover the horn with a cloth to muffle the alarm during this time.

Please note that the memory will also be reset when the unit is unpowered.

4. WHERE TO PLACE CO ALARMS

3.1 Ideally a Carbon Monoxide Alarm should be installed in:

- Every room containing a fuel burning appliance, and
- Remote rooms where occupants spend a considerable amount of time
- Every bedroom.

However if the number of Carbon Monoxide Alarms is limited the following points should be considered when deciding where best to fit the alarm(s)

- If there is an appliance in a room where people sleep, place a CO Alarm in this room and
- Locate a CO alarm in a room containing a flueless or open-flued appliance, and
- Locate an alarm in a room where the occupant(s) spend most of their time (e.g. sitting room) and
- In a bedsit, the CO alarm should be placed as far away from the cooking appliance as possible, but near to where the person sleeps and
- If the appliance is in a room not normally used, such as a boiler room, the CO alarm should be placed just outside the room so that the alarm will be heard more easily.

3.2 Unsuitable Locations

Do not place the CO Alarm in any of the following areas.

- (1) In the immediate vicinity of a cooking appliance (keep it at least 1 metre horizontally from it).

- (2) Outside the building.
- (3) In an enclosed space (e.g. in or below a cupboard).
- (4) In a damp or humid area.
- (5) Directly above a sink or cooker.
- (6) Next to a door, window, air vent or anywhere that it would be affected by draughts.
- (7) Next to an extractor fan.
- (8) Where it would be obstructed, e.g. by curtains or furniture.
- (9) In an area where the temperature could drop below -10°C or rise above 40°C .
- (10) Where dirt or dust could block the sensor.
- (11) Where it could be easily knocked or damaged, or where it could be accidentally turned off or removed.
- (12) In a bathroom or other areas where the CO alarm may be exposed to water splashes, dripping or condensation (e.g. above an electric kettle).
- (13) Near paint, thinners, solvent fumes or air fresheners.

3.3 If locating the CO alarm in a room with a fuel burning appliance (see figure 2)

- If it is mounted on a wall, it should be located at a height greater than the height of any door or window but still be at least 150mm from the ceiling.
- If it is mounted on the ceiling it should be at least 300mm from any wall or light fitting.

- The CO alarm should be a horizontal distance of between 1m and 3m from the potential CO source.
- If there is a partition in the room, the CO alarm should be located on the same side of the partition as the potential source.
- In rooms with sloped ceilings, the CO alarm should be located at the high side of the room (see fig 3).

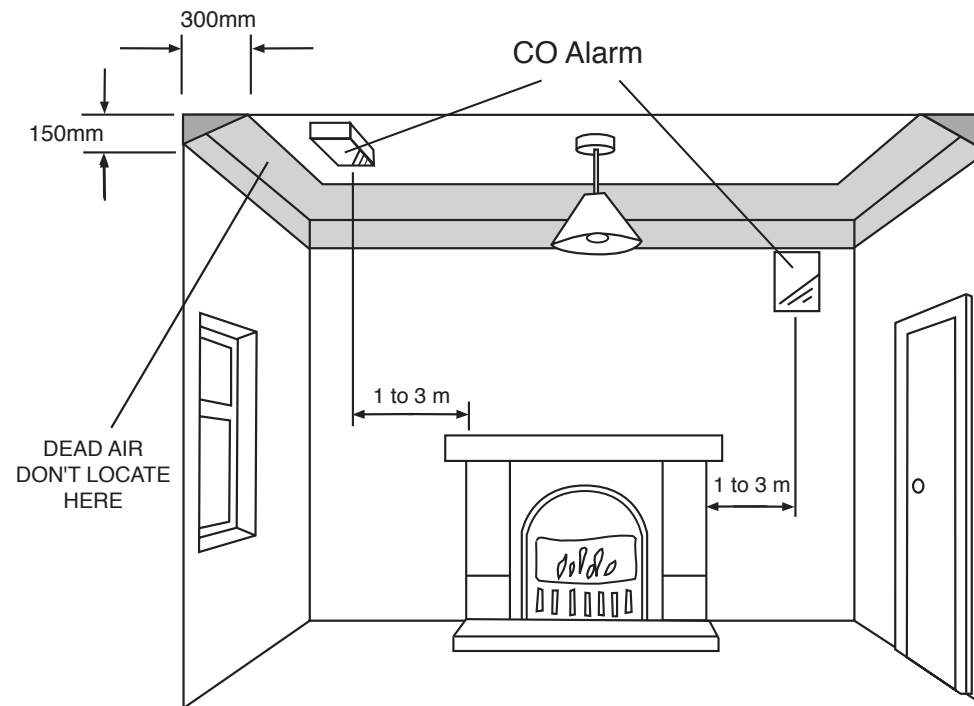

Figure 2. Location in room with a fuel burning appliance

3.31 If locating the CO alarm in a bedroom or in rooms remote from a fuel burning appliance (see figure 4)

- Mount the CO alarm relatively close to the breathing zone of the occupants.

Whatever position is chosen make sure it is possible to view the three light indicators, when in the vicinity of the alarm.

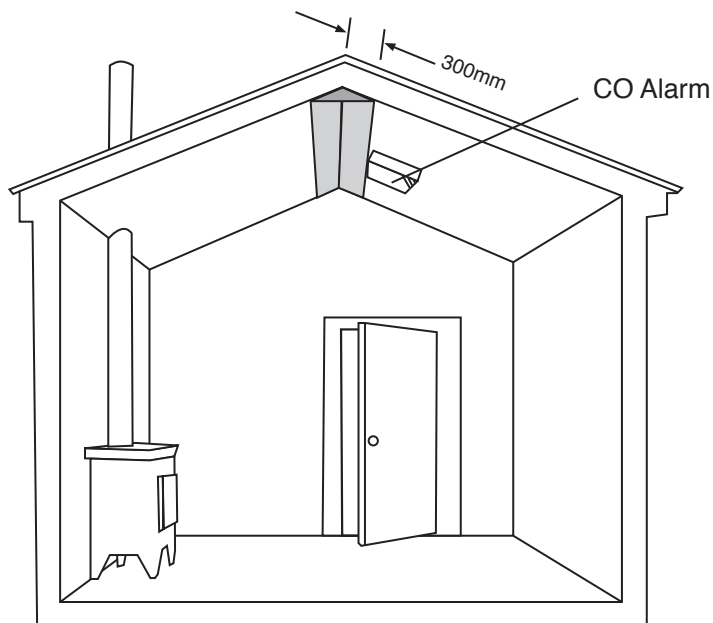

Figure 3. Location in rooms with sloped ceilings, the CO alarm should be located at the high side of the room

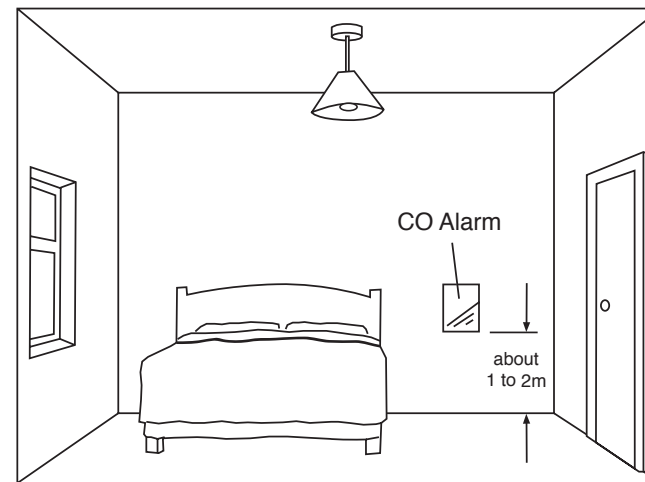

Figure 4. Location in bedroom & rooms remote from the appliance (i.e. at breathing level)

5. INSTALLING YOUR CARBON MONOXIDE ALARMS

The Alarm is designed to be permanently mounted. The unit can be screwed directly to the wall or ceiling and connected to the mains. It requires a current of 60mA. The Alarm must not be exposed to dripping or splashing. There are important markings on the underside of the alarm.

IMPORTANT PRECAUTION: Do not install the actual alarm itself in new or renovated buildings until all work is completed (including floor coverings) and the building has been fully cleaned. The wiring can be installed when appropriate. (Excessive dust and debris from building work can contaminate the sensor and cause problems, it will also invalidate the guarantee). If it must be installed, cover it completely, particularly around the edges, with a dust cover, until all cleaning is finished.

The Ei225EN Alarm must **not** be connected when the house wiring insulation is being checked with high voltages i.e. don't use an insulation tester on the alarm.

WARNING: Do not use the CO Alarm on an intermittent basis, or as a portable detector for the spillage of combustion products from fuel burning appliances or chimneys.

WARNING: The Alarm must be continuously powered 24 hours a day so it is important that it is not on a circuit that can be turned off by a switch.

INSTALLATION PROCEDURE

Ei225EN (Only)

Warning: The CO alarm should be installed by a qualified electrician in accordance with the IEE wiring regulations (BS 7671). Failure to install this alarm correctly may expose the user to shock or fire hazards.

Procedure:

1. Select a location complying with the above advice.
2. Disconnect the AC mains supply from the circuit to be used.
3. Slide off the cover as shown in fig 1. Press gently in the centre to release the catches before sliding upwards.
4. Remove the terminal cover screw and expose the connecting terminals.
5. (a) If the wires are coming directly out from the ceiling/wall locate the wire entry slot over the wires and mark the two mounting screw locations. Screw the unit to the ceiling/wall (ensure screws do not penetrate buried wires. The unit can also be screwed on to a standard recessed junction box if required. Seal the wire exit holes (with silicone or similar) to prevent air draughts preventing the carbon monoxide from reaching the sensor.
(b) If surface wiring is being used, bring the wiring in from either of the vertical sides or the bottom as shown in figure 5. Note surface wiring cannot be brought in from the top as it would be in the way of the cover sliding off and also might allow water to penetrate. Screw the unit to the wall.

6. The Brown wire (terminal 3) must be connected to the house wiring coloured brown or to a house terminal marked "L". The Blue wire (terminal 4) must be connected to the house wiring coloured blue or to a house terminal marked "N".

The alarm does not need to be earthed, however for convenience a spare terminal (no. 5) is provided to hold an earth wire if present.

7. Turn on the mains power to the CO Alarm circuit.

Figure 5 - Surface Wiring

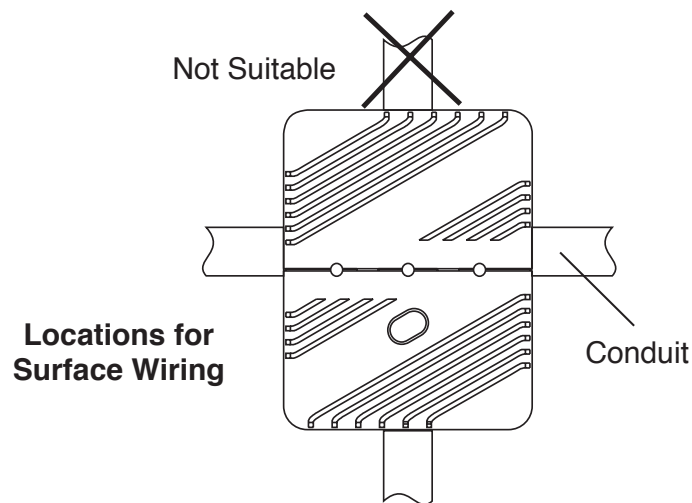
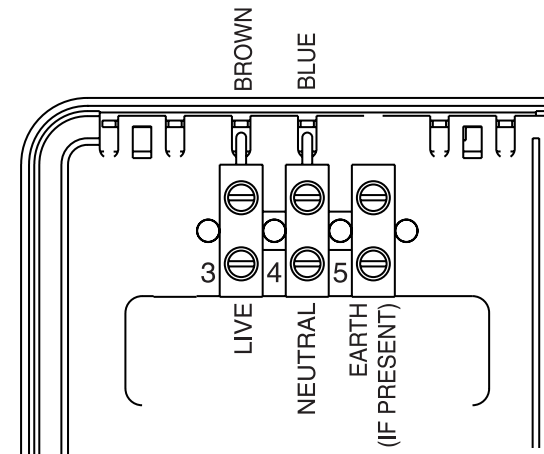

Figure 6 - Recessed Wiring



Ei220EN (Only)

1. Slide the cover off as shown in Figure 7 to expose the mounting screw holes.
2. Cut a notch in the back sidewall (on the centre of either side or at the bottom, for the power cord) to allow the unit to lie flush against the ceiling/wall.
3. Mark the two screw locations. Drill suitable holes (6mm drill) then insert the plastic anchors and screw the unit to the ceiling/wall.
4. Insert the plug into a suitable socket.

Warning: Do not open (apart from the cover shown in figure 7) or tamper with the CO Alarm. There are no user serviceable parts inside. This can damage the unit and may expose the user to shock or fire hazards.

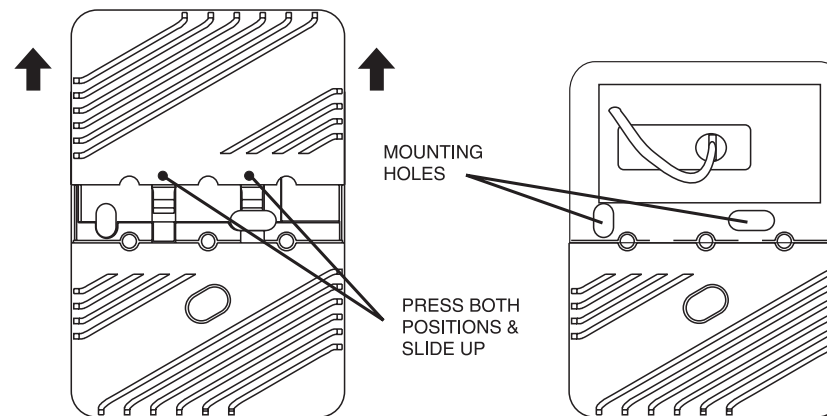
Figure 7

6. TESTING YOUR CO ALARM

- (1) Regularly check that the green mains power light is on. The unit cannot detect CO if the mains power is not on. (If it is off check circuit breakers, fuses, wiring etc).
- (2) Test the unit weekly by pressing the test/hush button. Hold the test button (for up to 10 seconds) until the horn sounds for over 5 seconds. This will help to familiarise you and your family with the distinctive on-off sound of the CO Alarm. This test checks that the electronics and horn are working correctly. (If the red alarm light flashes when the button is pressed - see CO Alarm Memory section on page 10).
- (3) If the CO Alarm gives a short beep and the amber fault light flashes every 40 seconds it means the self-checking circuit has detected a fault. Press and hold the test/hush button. If the amber light flashes without the horn sounding, the sensor is faulty.
- (4) If the Alarm fails to operate when the test/hush button is pressed, disconnect the mains supply at the distribution fuse board for 3 minutes. Re-connect the mains and try again. (This procedure resets the microprocessor in the unit).
- (5) If the CO Alarm fails any of the above tests it must be replaced immediately (see section 11 "Getting the CO Alarm Serviced" on page 28).

Testing with Carbon Monoxide

The unit can be tested with CO by using one of the kits that comes with CO either in a glass phial or aerosol can. Follow the instructions on the kit. It is best if possible to

inject the CO gas into the gas entry holes, see Figure 1. When it senses the CO it flashes the red light (as per Table B) to confirm that is detecting CO gas.

How to distinguish between CO Alarm and Smoke Alarm Warnings

The CO Alarm has a distinctive on-off sound of 3 pulses, followed by a pause as compared with a typical Smoke Alarm which has a rapid pulsing sound.

In addition, when your CO Alarm is sounding, the red alarm light in the centre of the cover will be flashing.

Testing both your CO Alarms and Smoke Alarms weekly will help you and your family to clearly distinguish between them in an emergency.

7. MAINTAINING YOUR CO ALARM

Clean the outside case by occasionally wiping with a clean damp cloth, (after first disconnecting the mains supply on an Ei225EN unit at the distribution/fuse board or by unplugging the Ei220EN unit). Do not use any cleaning agents, bleaches, detergents or polishes, including those in aerosol cans. Avoid spraying air fresheners, hair spray, paint or other aerosols near the CO Alarm. Do not place air fresheners near the unit.

Use the narrow nozzle of a vacuum cleaner to remove fluff and other contamination from the cover slots to ensure CO gas can reach the sensor.

Caution: Do not paint the CO Alarm.

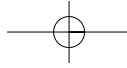

Remove the CO Alarm when decorating. Do not allow water or dust to contaminate the alarm.

Warning: Do not open or tamper with the CO Alarm. There are no user serviceable parts. This can damage the unit and may expose the user to shock or fire hazards.

END OF LIFE

When the unit has completed up to 6 years of operation the amber light will flash every 40 seconds. The entire unit must then be replaced.

It must also be replaced when the date on the 'Replace unit by' label on the side wall is exceeded.

Product Disposal

The crossed out wheellie bin symbol on the product means that it should not be put into household waste. Please recycle where facilities exist. Check with your local authority or retailer for recycling advice.



The date code on the product indicates when the product was manufactured e.g. 05W40 means week 40 in the year 2005.

How to disconnect and remove the alarm:

Ei225EN only

1. First disconnect the mains supply to the CO Alarm circuit at the distribution / fuse board.
2. Slide cover up as shown in figure 1.

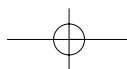

3. Unscrew the terminal cover screw.
4. Disconnect the wires from the terminal block and make safe, particularly if the circuit is going to be turned on again after the CO Alarm is removed.
5. Unscrew from the wall.

Ei220EN only

1. Unplug the unit.
2. Slide cover up as shown in figure 7.
3. Unscrew from the wall.

8. LIMITATIONS OF CO ALARMS

- (1) The CO Alarm will not work without mains power. The green power light must be on at all times as far as possible.
- (2) Carbon Monoxide must enter the unit for it to be detected. There may be Carbon Monoxide in other areas of the house (e.g. downstairs, in a closed room etc). but not in the vicinity of the CO Alarm. Doors, air draughts and obstructions can prevent the CO reaching the Alarm. For these reasons we recommend CO Alarms are fitted both near and in bedrooms, particularly if bedroom doors are closed at night. Additionally install in rooms where members of the household spend much of their time, and in rooms with potential sources of CO gas.

(3) The CO Alarm may not be heard. The sound output is loud but it may not be heard behind a closed door or if it is too far away. The Alarm may not wake up somebody who has taken alcohol or drugs. The alarm sound may be masked by other sounds such as T.V., stereo, traffic noise etc. Fitting CO Alarms on either side of closed doors will improve their chance of being heard. This CO Alarm is not designed for people with impaired hearing.

(4) CO Alarms don't last indefinitely. CO Alarms are sophisticated electronic devices with many parts. Although the alarm and its component parts have undergone stringent tests, and are designed to be very reliable, it is possible that parts can fail. Therefore, you should test your CO Alarm weekly. The CO Alarm must be replaced after up to 6 years operation (see 'Replace by' date on side wall label).

(5) CO Alarms are not a substitute for life insurance. House-holders are responsible for their own insurance. The CO Alarm warns of increasing CO levels, but we do not guarantee that this will protect everyone from CO poisoning.

(6) CO Alarms are not suitable as early warning Smoke Alarms. Some fires produce Carbon Monoxide, but the response characteristics of these CO Alarms are such that they would not give sufficient warning of fire. Smoke Alarms must be fitted to give early warning of fire.

The CO Alarm does not detect the presence of natural gas (methane), bottled gas (propane, butane) or other combustible gases. Fit combustion gas alarms to detect these.

WARNING: THIS CO ALARM IS DESIGNED TO PROTECT INDIVIDUALS FROM

THE ACUTE EFFECTS OF CARBON MONOXIDE EXPOSURE. IT WILL NOT FULLY SAFEGUARD INDIVIDUALS WITH SPECIFIC MEDICAL CONDITIONS. IF IN DOUBT CONSULT A MEDICAL PRACTITIONER.

9. HOW TO PROTECT YOUR FAMILY

Follow these guidelines to reduce the risk of Carbon Monoxide poisoning.

(1) Know and look out for tell-tale signs that Carbon Monoxide may be present. These include:-

- The CO Alarm warning of abnormal levels.
- Staining, sooting or discolouration on or around appliances.
- A pilot light frequently going out.
- A strange smell when an appliance is working.
- A naked gas flame which is yellow or orange, instead of the normal blue.
- Family members (including pets) exhibiting the “flu-like” symptoms of CO poisoning described above.

If any of these signs are present get the appliance checked out by an expert before further use. If family members are ill get medical help.

(2) Choose all appliances and vehicles which burn fossil fuels such as coal, oil, natural/bottled gas, paraffin, wood, petrol, diesel, charcoal etc. with care and have them professionally installed and regularly maintained.

(3) These appliances must “breathe in” air to burn the fuel properly. Know where the

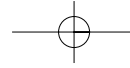

air comes from and ensure vents/air bricks etc. remain unobstructed (particularly after building work).

- (4) The appliances must also “breathe out” the waste gases (including the CO) – usually through a flue or chimney. Ensure chimneys and flues are not blocked or leaking, and get them checked every year. Check for excessive rust or cracks on appliances and pipe work.
- (5) Never leave your car, motor bike or lawnmower engine running in the garage with the garage door closed. Never leave the door from the house to the garage open if the car engine is running.
- (6) Never adjust your own gas pilot lights.
- (7) Never use a gas cooker or a barbecue for home heating.
- (8) Children should be warned of the dangers of CO poisoning and instructed never to touch, or interfere with the CO Alarm. Do not allow small children to press the test/hush button as they could be subjected to excessive noise when the unit alarms.
- (9) Leaving windows or doors slightly open (even a few inches) will significantly reduce the risk of high levels of CO occurring. The high levels of draught-proofing in modern houses reduces ventilation and can allow dangerous gases to build up.
- (10) Install CO Alarms in all the areas recommended in this leaflet.
- (11) Recognise that CO poisoning may be the cause when family members suffer from “flu-like” symptoms when at home but feel better when they are away for extended periods.

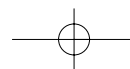
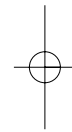
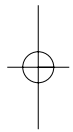

10. TECHNICAL SPECIFICATION

Operating Voltage	: 230±10% VAC, 50Hz
Power	: 1 Watt, (60 mA)
Power on Indicator	: Green Light on
Sensor	: Electrochemical Sensor
CO Sensitivity	: Meets BS EN 50291: 2001. Unit operates as per Table B (page 9).
Electrical Safety	: Complies with relevant sections of EN 60335-1: 1994
Electromagnetic Compatibility	: Complies with BS EN 50270
Test/Hush Button	: Checks electronics and horn. When the unit is alarming, after sensing CO, pressing the test/hush button will immediately stop the horn (the red light will continue to flash). If CO is still present the red light and the horn will turn on again after about 4 minutes. The unit can only be silenced once during a CO incident. At 300 ppm CO the unit cannot be silenced. (With interconnected units, the hush only works on the alarm sensing CO).
Testing with CO	: The red light flashes (see Table B, page 9) within 10 seconds of the unit detecting CO.

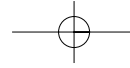

- Initialisation Time : 70 seconds. On power up red and amber lights flash momentarily to show they are operational.
- Operating Temperature : -10°C to 40°C
- Humidity Range : 15% to 95% R.H. (non-condensing)
- Audible Alarm : 85dB(A) at 3m minimum
- Self Diagnostics : Horn beep and amber fault light flashes every 40 seconds if a sensor fault is found.
- Tamperproof : Ei225EN - Screwdriver needed to unscrew unit from wall. Mains cover over terminal block screw must also be removed.
Ei220EN - Screwdriver needed to unscrew unit from wall.
- End of Life Indication: Amber light flashes every 45 seconds after 6 years to show the unit must be replaced.
- CO Alarm Memory: : A unit will indicate if it has been in alarm previously by flashing the red light for 2 seconds every 40 seconds (2 flashes for 50 ppm CO, 4 flashes for 100 ppm CO and 8 flashes, for 300 ppm CO). When the test button is pressed the red light flashes as per table B and also indicates the previous CO alarm level detected. The memory is cleared by holding down the test button until the red light stops flashing or if the unit is unpowered.

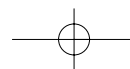
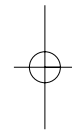
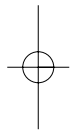

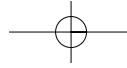

Dimensions : 135 x 105 x 71 mm.
Weight : 195g - Ei225EN
290g - Ei220EN

11. GETTING THE CO ALARM SERVICED

If your CO Alarm fails to work after you have carefully read all the instructions, checked the unit has been installed correctly, and is receiving AC power, - see “How to disconnect and remove the Alarm” in section 7, page 20. Return it for repair or replacement. This should be to where it was purchased, alternatively return it in a padded box to “Customer Assistance and Information” at the nearest address given on the CO Alarm or in this leaflet. State the nature of the fault, where the CO Alarm was purchased, and the date of purchase.

12. GUARANTEE

Ei Electronics guarantees the Ei225EN Carbon Monoxide Alarm for five years from the date of purchase against any defects that are due to faulty materials or workmanship.

Ei Electronics guarantees the Ei220EN Carbon Monoxide Alarm for two years from the date of purchase against any defects that are due to faulty materials or workmanship. This guarantee only applies to normal conditions of use and service, and does not include damage resulting from accident, neglect, misuse, unauthorised dismantling, or contamination howsoever caused.

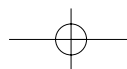

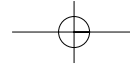

This guarantee excludes incidental and consequential damage. If this Carbon Monoxide Alarm should become defective within the guarantee period, it must be returned to where it was purchased or alternatively to Ei Electronics., carefully packaged, with the problem clearly stated. (see section 11 “Getting the CO Alarm Serviced”) along with proof of the date of purchase. We shall at our discretion repair or replace the faulty unit.

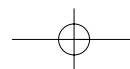
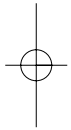

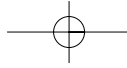

13. TROUBLESHOOTING

1. ALARM DOES NOT WORK WITH THE TEST BUTTON:

- (1) Check that the green mains power light is on. If it is off check the wiring, fuse, circuit breakers etc.
- (2) Hold the test button down for at least 5 seconds.

2. ALARM BEEPS AND AMBER LIGHT FLASHES EVERY 40 SECONDS:

If the alarm beeps and the amber fault light flashes every 40 seconds, the CO sensor is probably defective. Press the test/hush button to reset the unit. If the beeping and the amber light flashing re-occurs replace the unit.

3. AMBER LIGHT FLASHES EVERY 40 SECONDS

The unit has been operating for up to 6 years and must be replaced.

4. ALARM SOUNDS FOR NO APPARENT REASON:

Follow the detailed instructions on page 4. entitled “**What to do when the alarm sounds**”. If there are still problems:

- (1) Ensure there are no fuel-burning appliances in the vicinity which could be leaking CO gas (e.g. even from next door).

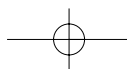

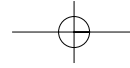

- (2) Ensure there are no fumes in the area (e.g. paint, thinners, alcohol, hair spray, chemical cleaners aerosol sprays etc).
- (3) Ensure there is no outdoor source of CO in the vicinity (e.g. a car with engine running, heavy traffic, heavy air pollution, barbecue fumes etc).
- (4) Press the test/hush button to silence the alarm.

If the unit continues to sound it is possibly defective and should be replaced, follow the instructions in section 7 on “How to disconnect and remove your alarm” and then see section 11 “Getting the CO Alarm Serviced”.

4. TEST/HUSH BUTTON DOES NOT SILENCE ALARMS:

Hush button will only silence the unit once at CO levels less than 300 ppm CO during a CO incident.

5. THE RED AND AMBER LIGHTS FLASH:

On power up the red and amber lights turn on in sequence to show they are working.
THIS IS NORMAL.

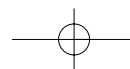

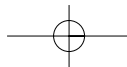

Ei Electronics

Shannon, Co. Clare, Ireland.

Tel: (061) 471277 Fax: (061) 471053

E-mail: helpdesk@eiltd.ie

www.eielectronics.com

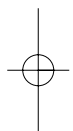

Aico Ltd.

Mile End Business Park, Maesbury Rd, Oswestry,
Shropshire, SY10 8NN,

U.K. Tel: 0870 7584000 Fax: 0870 7584010

E-mail: support@aico.co.uk

www.aico.co.uk

